

Keysight E5063A

ENA Vector Network Analyzer

100 kHz to 500 M/1.5 G/3 G/4.5 G/6.5 G/8.5 G/14 G/18 GHz

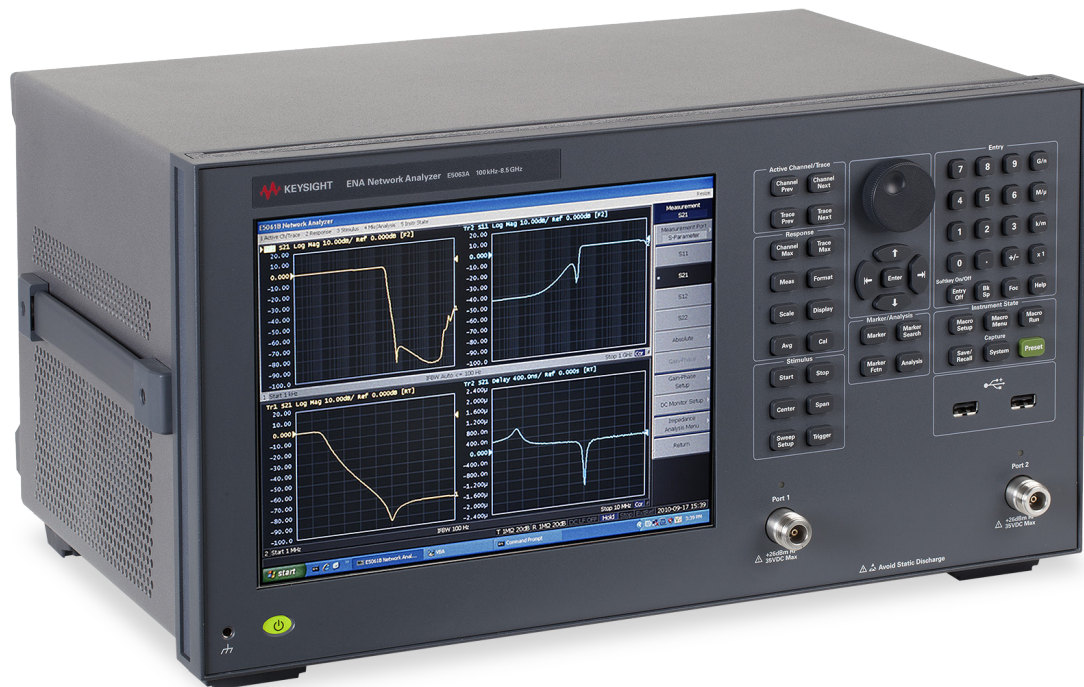

The Best Balance Between Price and Performance

The Keysight E5063A ENA is an affordable benchtop vector network analyzer (VNA) for testing simple passive components such as antennas, filters, cables or connectors up to 18 GHz. The E5063A provides the best balance between price and performance to satisfy your business and technical requirements. It leverages the consistent measurement framework of the industry standard ENA Series to boost efficiency and productivity, and is future proof and ready to evolve as the technologies change.

DUT examples

- Antennas for smartphones, cellular base stations, WLAN, and other wireless communication devices
- Other simple RF passive components such as filters, cables, connectors, attenuators, couplers, isolators, and dividers
- Impedance test of PC board (PCB)
- Wireless power transfer coils/resonators
- Dielectric materials



E5063A highlights	
Frequency ¹	100 kHz to 500 MHz (Option 205) 100 kHz to 1.5 GHz (Option 215) 100 kHz to 3 GHz (Option 235) 100 kHz to 4.5 GHz (Option 245) 100 kHz to 6.5 GHz (Option 265) 100 kHz to 8.5 GHz (Option 285) 100 kHz to 14 GHz (Option 2D5) 100 kHz to 18 GHz (Option 2H5)
Test port	2-port 50 Ω S-parameter test set
Dynamic range	117 dB (spec), 122 dB (typical)
Trace noise	0.005 dBrms (spec), 0.002 dBrms (typ.)
Stability	0.01 dB/°C
Source power	-20 to 0 dBm
Sweep type	Linear & Log frequency, Segment
NOP	10,001 points (Max.)
Channel	32 channels (Max.)
Key software capability	Fixture simulator, Time domain analysis/Test Wizard option ² , Wireless power transfer analysis, and Materials measurement ³
Interface	LAN, USB (front 2, rear 4), USBTMC, GPIB ⁴ , Handler I/O ⁴
Display	10.4 inch multi-touchscreen
Operating system	Windows 10

1. The E5063A starting frequency can be set down to 50 kHz.
2. Consists of conventional time domain analysis capabilities and GUI for PCB test.
3. External software (Keysight N1500A Material Measurement Suite) required.
4. Optional capability.

Drive Down The Cost of Test for RF Passive Components

Solid performance at an affordable price

The E5063A delivers a great combination of performance, accuracy and repeatability all at an affordable price. The E5063A is a safe investment to lower your total cost of ownership.

- Trace noise (0.002 dBrms^1) and stability ($0.01 \text{ dB}/\text{C}^2$)
 - The best-in-class performance comparable to higher-end ENA models
 - Enables accurate measurements of low-loss devices
 - Dynamic range (maximum 122 dB^3)
 - Satisfies test requirements of simple RF passive components.

You can choose the best suited frequency range from 8 different frequency options (500 M/1.5 G/3 G/4.5 G/6.5 G/8.5 G/14 G/18 GHz) depending on your test needs and budgets. In addition, the frequency upgradability allows you to start your investment with the lower-priced 500 MHz option and later upgrade it to higher frequency options up to 18 GHz options when necessary. Optimize your investment for your current and future needs with the E5063A.

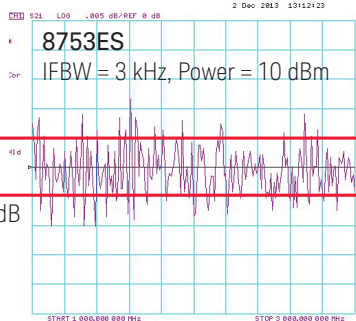
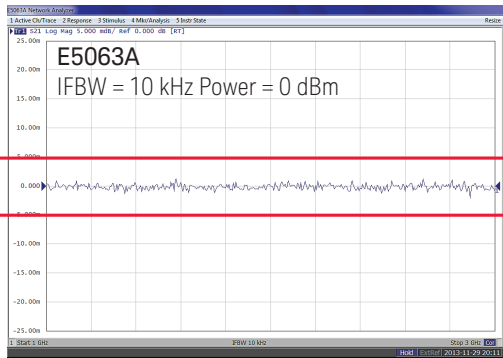
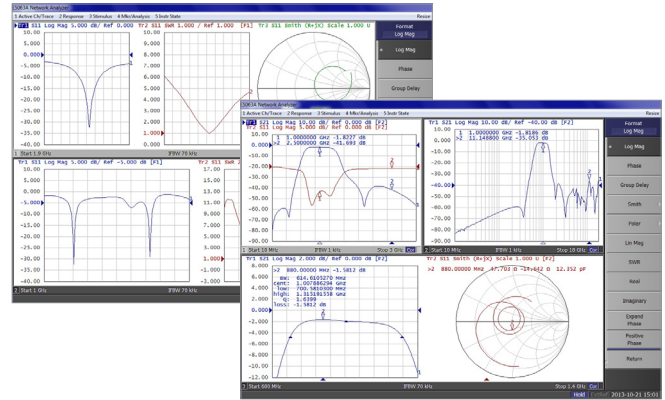

Trace noise (S21 measurement of thru, at 1 to 3 GHz)

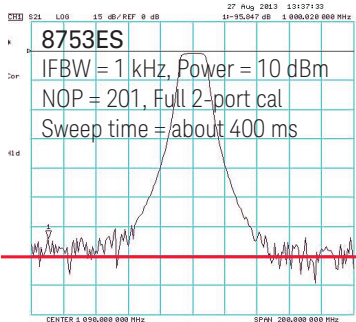
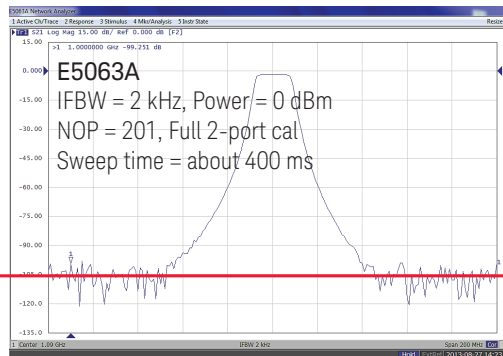

Dynamic range (S21 measurement of 1 GHz band-pass filter)

1. Typical, transmission measurement, at 8 M to 4.35 GHz, IFBW = 70 kHz
2. Typical, at 300 k to 6 GHz
3. Typical, at 100 M to 4.35 GHz, IFBW = 10 Hz

Ready for Production Testing

Proven calibration and analysis capabilities

The E5063A fully supports major calibration and data analysis capabilities that are compatible with the E5071C and required for testing RF passive components. With these proven capabilities, the E5063A provides measurements consistent with the industry standard E5071C.

- Calibration capabilities
 - SOLT cal (with known thru, or unknown thru)
 - Adapter removal/insertion
 - ECal (Electronic Calibration)
 - TRL cal
- Fixture simulator
 - Virtual matching circuit embedding
 - De-embedding
 - Port-Z conversion
 - 1-port mixed-mode S-parameters
- Data analysis
 - Equation editor
 - Point limit (for antennas)
 - Ripple & Bandwidth limit (for filters)
 - Single marker search for max, min, peak, or target value
 - Multiple marker search for peaks or target values

In addition, Chinese language support via softkey and the embedded help manual further improves usability for Chinese users.

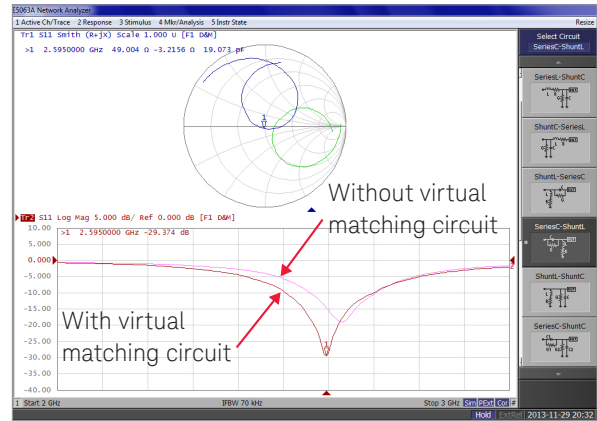

Embedding matching circuit in antenna measurement

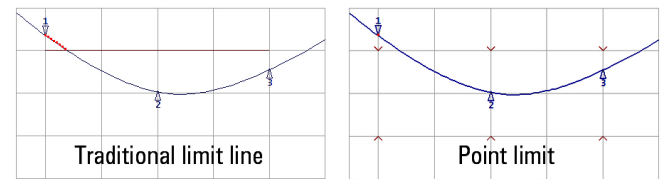

Limit test functions

Improve your productivity with ECal calibration

Keysight offers a variety of calibration kits with different connector types, frequency ranges, or prices. Keysight also offers electronic calibration (ECal) modules. The ECal is a solid-state device with programmable, and repeatable impedance states, and requires only one set of connections to perform a calibration. Therefore it greatly improves your productivity and minimizes operator's error.

The Keysight N755xA series is the economy 2-port ECal family equipped with either Type-N or 3.5 mm connectors which offers the convenience of an ECal at a lower price point. The N755xA is supported by the E5063A with the firmware revision A.03.72 or above to lower your cost of ownership.



The N755xA series ECal module

E5063A ENA Series PCB Analyzer

The best solution for PCB manufacturing test

As the operating speed of electronic circuits increase, signal integrity of printed circuit boards (PCBs) drastically affects performance and there is an increasing requirement for controlled impedance PCBs. In addition, with the proliferation of wireless devices, such as smartphones and tablets, there is a trend to integrate antennas onto PCBs. Therefore, in addition to the traditional time domain impedance measurement, there is a growing need to measure the frequency domain response of PCB integrated antennas.

The E5063A PCB Analyzer requires the E5063A Option 011 (Time domain analysis/Test Wizard). The E5063A provides frequency domain measurement capability and Option 011 adds time domain analysis capability, as well as a dedicated graphical user interface for PCB manufacturing test¹.

Compared to traditional solutions based on sampling oscilloscopes, the E5063A PCB Analyzer provides three breakthroughs for PCB manufacturing test:

- More Accuracy and R&R (Repeatability & Reproducibility)
- More Languages Supported
- More ESD Robustness

More accuracy and R&R

Delivers new standards in speed and accuracy

- Low noise floor for accurate and repeatable measurements
- State of the art error correction techniques enables you to measure your device, not your measurement system
- Fast measurement speed for improved throughput

More languages supported

An analyzer that speaks the user's language

- Since there are many cases where tasks are solved more efficiently in one's native language, a multi-lingual interface is provided with the graphical user interface.
- Currently available languages include English, Simplified and Traditional Chinese, Japanese, and Korean

More ESD robustness

Protection circuits implemented inside the instrument

- Proprietary electrostatic discharge (ESD) protection chip significantly increases ESD robustness, while at the same time maintaining excellent RF performance
- Highly robust architecture can minimize instrument failure from ESD and free you from worrying about instrument repair fees and downtime

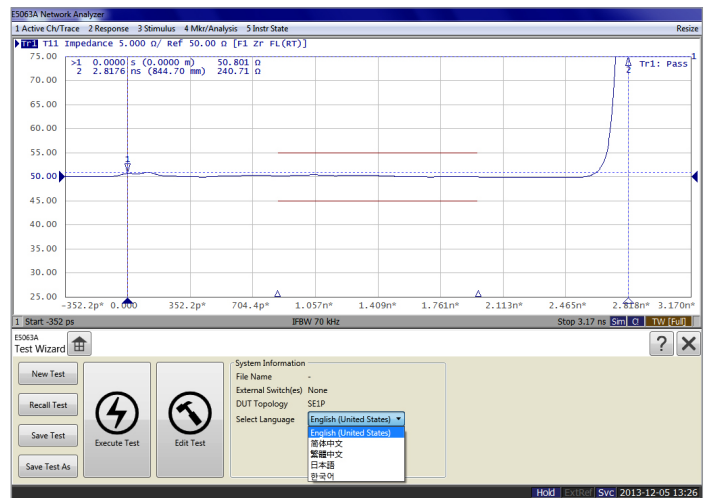

Intuitive software supporting multiple languages

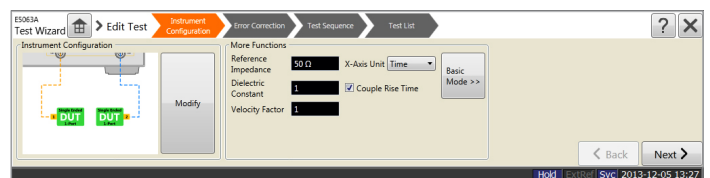

Edit test mode

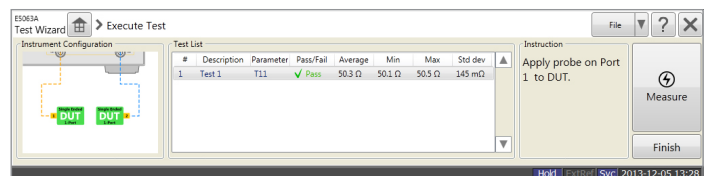

Execute test mode

1. For more details, refer to the application note, "Achieving Higher Measurement Accuracy and Better Correlation for PCB Impedance Test", 5992-0589EN.

Wireless Power Transfer Analysis

With the evolution of cloud computing systems and highly integrated mobile terminals, various types of digital contents and applications can be enjoyed in the palm of your hand today. As a result, power consumption in mobile terminals rapidly increases, raising demands for more convenient and versatile ways of battery charging. Wireless Power Transfer (WPT) technology has drawn much attention recently as one of the realistic solutions and is widely discussed and researched.

Power transfer efficiency in WPT systems is one of the challenges for WPT technology, and it largely relies on quality of components used in these systems. To ensure system performance and interoperability, it is important to specify test requirements and perform tests of coils or resonators in both transmitters and receivers.

The E5063A offers a software solution (E5063A Option 006) to analyze voltage, current, and power transfer efficiency of WPT systems in real-time from 50 ohm based S-parameter measurements. You can also define arbitrary load impedance to simulate power transfer efficiency when batteries are connected. Measurement results of frequency, resistance (R) or reactance (X) of the load impedance can be visualized in 2D or 3D to help you more easily understand the dependency of load impedance in your system¹.

Maximize your power transfer efficiency

- Display wireless power transfer efficiency between coils or resonators in real-time
- Capable of setting arbitrary load impedance
- 2D/3D simulation of load impedance dependency to search for the maximum efficiency
- Network analysis data output for further circuit modeling and simulation in Keysight ADS simulator
- Wireless power transfer analysis available in the E5063A lowest-cost ENA vector network analyzer

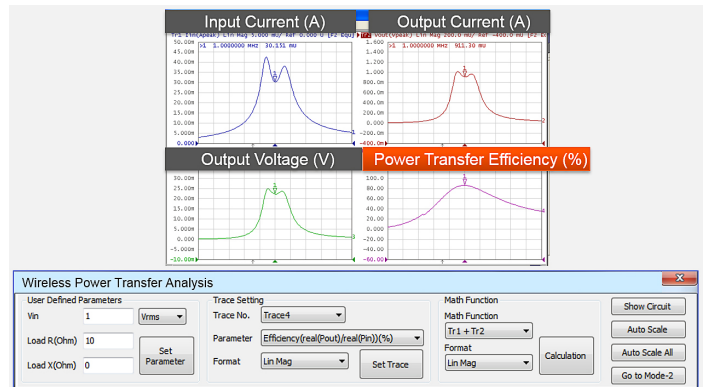
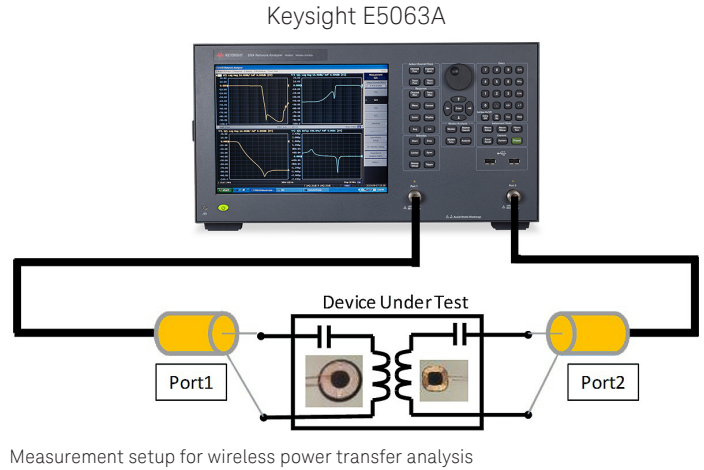

Real-time wireless power transfer analysis in Mode-1

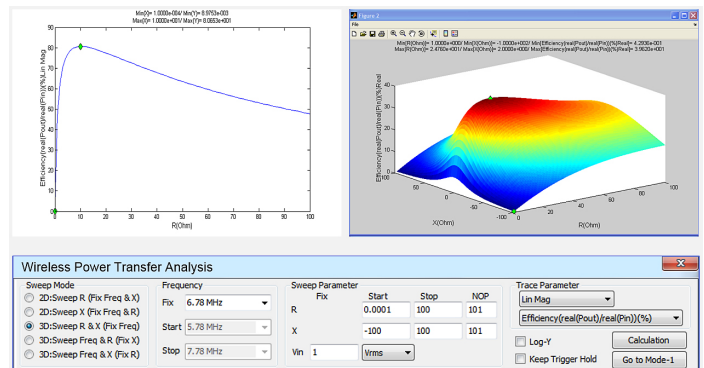

Advanced 2D/3D simulation in Mode-2

1. For more details about the WPT analysis with the ENA vector network analyzer, visit the Keysight website, www.keysight.com/find/ena-wpt
www.keysight.com/find/vna

Additional Software Capabilities

Materials measurement software

A dielectric materials measurement can provide critical design parameter information for many electronics applications such as complex permittivity, loss tangent or permeability. Keysight offers a variety of instruments, fixtures, and software to measure the dielectric properties of materials. The N1500A materials measurement suite is available to calculate dielectric properties from S-parameter measurements using Keysight vector network analyzers including the E5063A. For more details about materials measurement solutions, visit Keysight website, www.keysight.com/find/materials

Fixtures to hold the material under test (MUT) are available that are based on coaxial probe, parallel plate, transmission lines or resonant cavity methods. The type of fixture required will depend on the chosen measurement technique and the physical properties of the material (solid, liquid, powder, gas).

- The N1501A dielectric probe kit includes the coaxial probe, probe stand and cable
- The N1501AExx split post dielectric resonators (SPDR) for thin sheet materials.



Dielectric properties measurements of PCB materials using the E5063A and N1501AExx test fixture

BenchVue software

Keysight BenchVue software for the PC eliminates the many of the issues around bench testing. By making it simple to connect, control instruments, and automate test sequences you can quickly move past the test development phase and access results faster than ever before with just a few clicks. A dedicated Network Analyzer app, available with BV9001B, allows you to quickly configure the most commonly used measurements and setups. Rapidly build custom test sequences with the integrated Test Flow app to automate and visualize test results without the need for instrument programming. BenchVue supports hundreds of Keysight instrument types and models all from one easy to use software platform. Control, Automate, Simplify with BenchVue.

- Easily control, get screen captures and trace data
- Capture measurements from your network analyzer in a single click
- Automate common network analyzer controls and measurements as quickly as using your front panel

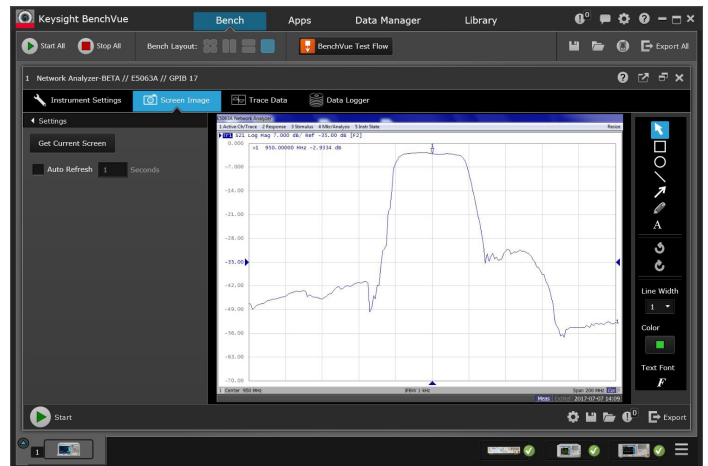

BenchVue: PC control, capture screen images or trace data, and build automated tests in minutes

E5063A key specs & features (comparison with E5061B & E5071C)

	E5063A	E5061B (RF NA Options)	E5071C
Frequency	100 kHz to 500M/1.5 G/3 G/4.5 G/6.5 G/8.5 G/14 G/18 GHz (settable down to 50 kHz)	100 kHz to 1.5/3 GHz	9/100 kHz to 4.5/6.5/ 8.5 GHz, 300 kHz to 14/20 GHz
Test port	2-port S-parameter, 50 Ω	2-port T/R & S-parameter, 50 or 75 Ω	2 & 4-port S-parameter, 50 Ω
Dynamic range	117 dB (spec), 122 dB (typical) (at 100 MHz to 4.35 GHz)	120 dB (spec), 130 dB (SPD) at 1 MHz to 3 GHz	123 dB (spec), 130 dB (SPD) (at 10 MHz to 6 GHz)
Trace noise	0.005 dBrms (spec) 0.002 dBrms (typical) (at 8 M to 4.35 GHz, IFBW = 70 kHz, transmission measurement)	0.005 dBrms (spec) (at 1 M to 3 GHz, IFBW = 3 kHz)	0.003 dBrms (spec) 0.001 dBrms (SPD) (at 10 M to 4.38 GHz, IFBW = 70 kHz, transmission measurement)
Stability	0.01 dB/°C (at 300 kHz to 6 GHz)	0.01 dB/°C (at 3 MHz to 3 GHz)	0.005 dB/°C (at 9 kHz to 3 GHz)
Source power	-20 to 0 dBm (at 300 kHz to 8.5 GHz)	-45 to +10 dBm (at 300 kHz to 3 GHz)	-55 to +10 dBm (at 9 kHz to 5 GHz)
Sweep type	Linear and log frequency, Segment	Linear and log frequency, Segment, Power sweep	Linear and log frequency, Segment, Power sweep
NOP	Max. 10,001	1,601	Max. 20,001
Channel	Max. 32	4	Max. 160
Measurement parameters	S-parameters (single-ended, mixed-mode), TDR and single-ended TDT parameters ¹ , Wireless power transfer efficiency ¹	S-parameters (single-ended), Absolute power, Wireless power transfer efficiency ¹	S-parameters (single-ended, mixed-mode), Absolute power, TDR and TDT parameters ¹
Calibration capabilities	SOLT, Adapter removal/insertion, ECal, TRL, Unknown thru, Waveguide	SOLT, Adapter removal/insertion, ECal, ECal user characterization	SOLT, Adapter removal/insertion, ECal, ECal user characterization TRL, Unknown thru, Waveguide, Power cal, Receiver cal, Scalar mixer cal (SMC), Vector mixer cal (VMC)
Other major capabilities	Time domain/Test Wizard ¹ , Wireless power transfer analysis ¹ , Limit test (Limit line, Ripple limit, Bandwidth limit, Point limit), Fixture simulator, Equation editor, U1810B/U1816A/C USB switch support	Time domain/SRL analysis ¹ , Wireless power transfer analysis ¹ , High-stability timebase ¹ , Limit test (Limit line, Ripple limit, Bandwidth limit), Equation editor, VBA	Time domain ¹ , TDR ¹ , FOM ¹ , High-stability timebase ¹ , Bias-tees ¹ , Limit test (Limit line, Ripple limit, Bandwidth limit, Point limit), Fixture simulator, Equation editor, VBA, E5092A mutiport test set support

1. Optional capabilities

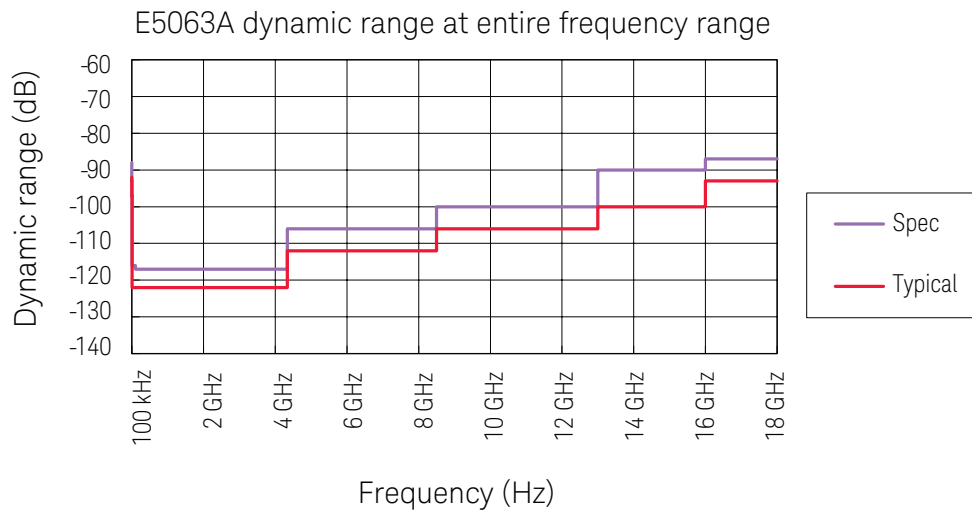

Literature Resources

Description	Publication number
<i>E5063A ENA Vector Network Analyzer, Data Sheet</i>	5991-3615EN
<i>E5063A ENA Vector Network Analyzer, Configuration Guide</i>	5991-3616EN
<i>E5063A PCB Analyzer, Technical Overview</i>	5991-3617EN
<i>Keysight Vector Network Analyzer Selection Guide</i>	5989-7603EN

More literature is available on our web site.

Web Resource

www.keysight.com/find/vna
www.keysight.com/find/ena-pcb
www.keysight.com/find/ecal
www.keysight.com/find/mta
www.keysight.com/find/materials
www.keysight.com/find/benchvue

Evolving Since 1939

Our unique combination of hardware, software, services, and people can help you reach your next breakthrough. We are unlocking the future of technology.

From Hewlett-Packard to Agilent to Keysight.

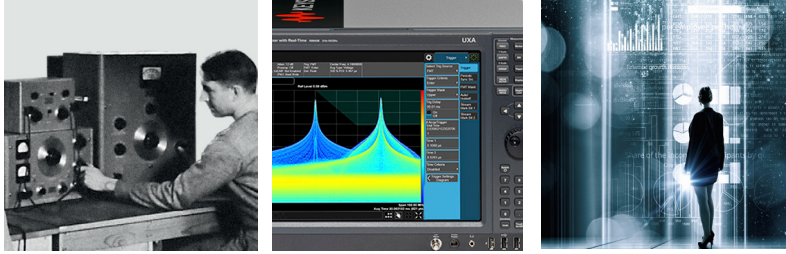

myKeysight

myKeysight

www.keysight.com/find/mykeysight

A personalized view into the information most relevant to you.

http://www.keysight.com/find/emt_product_registration

Register your products to get up-to-date product information and find warranty information.

KEYSIGHT SERVICES

Accelerate Technology Adoption.
Lower costs.

Keysight Services

www.keysight.com/find/service

Keysight Services can help from acquisition to renewal across your instrument's lifecycle. Our comprehensive service offerings—one-stop calibration, repair, asset management, technology refresh, consulting, training and more—helps you improve product quality and lower costs.



Keysight Assurance Plans

www.keysight.com/find/AssurancePlans

Up to ten years of protection and no budgetary surprises to ensure your instruments are operating to specification, so you can rely on accurate measurements.

Keysight Channel Partners

www.keysight.com/find/channelpartners

Get the best of both worlds: Keysight's measurement expertise and product breadth, combined with channel partner convenience.

For more information on Keysight Technologies' products, applications or services, please contact your local Keysight office. The complete list is available at:

www.keysight.com/find/contactus

Americas

Canada	(877) 894 4414
Brazil	55 11 3351 7010
Mexico	001 800 254 2440
United States	(800) 829 4444

Asia Pacific

Australia	1 800 629 485
China	800 810 0189
Hong Kong	800 938 693
India	1 800 11 2626
Japan	0120 (421) 345
Korea	080 769 0800
Malaysia	1 800 888 848
Singapore	1 800 375 8100
Taiwan	0800 047 866
Other AP Countries	(65) 6375 8100

Europe & Middle East

Austria	0800 001122
Belgium	0800 58580
Finland	0800 523252
France	0805 980333
Germany	0800 6270999
Ireland	1800 832700
Israel	1 809 343051
Italy	800 599100
Luxembourg	+32 800 58580
Netherlands	0800 0233200
Russia	8800 5009286
Spain	800 000154
Sweden	0200 882255
Switzerland	0800 805353
	Opt. 1 (DE)
	Opt. 2 (FR)
	Opt. 3 (IT)
United Kingdom	0800 0260637

For other unlisted countries:

www.keysight.com/find/contactus
(BP-9-7-17)



www.keysight.com/go/quality

Keysight Technologies, Inc.
DEKRA Certified ISO 9001:2015
Quality Management System

