

Agilent PNA Microwave Network Analyzers

Data Sheet

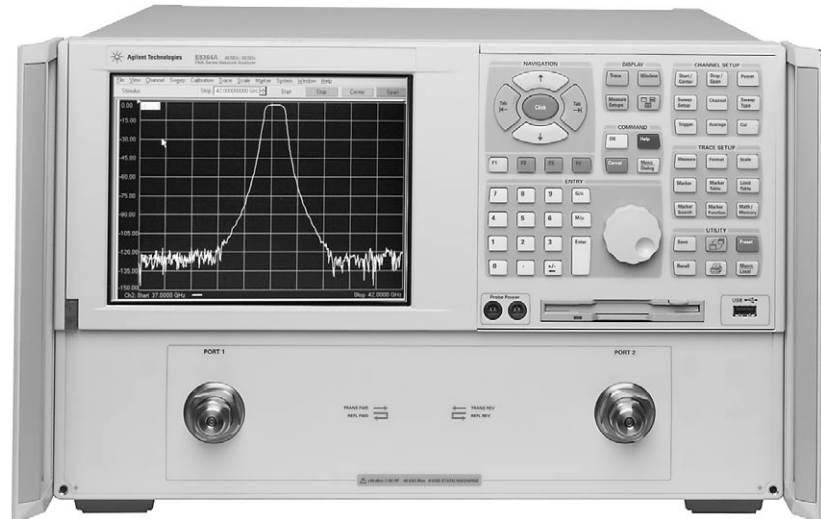

This document describes the performance and features of the Agilent Technologies PNA microwave network analyzers:

- | | |
|---------------|-------------------------|
| E8362B | 10 MHz to 20 GHz |
| E8363B | 10 MHz to 40 GHz |
| E8364B | 10 MHz to 50 GHz |
| E8361A | 10 MHz to 67 GHz |

NOTICE: In August 2014, Agilent Technologies' former Test and Measurement business became Keysight Technologies. This document is provided as a courtesy but is no longer kept current and thus will contain historical references to Agilent. For more information, go to www.keysight.com.



Agilent Technologies

Some Definitions

All specifications and characteristics apply over a 25 °C \pm 5 °C range (unless otherwise stated) and 90 minutes after the instrument has been turned on.

Calibration: The process of measuring known standards to characterize a network analyzer's systematic (repeatable) errors.

Characteristic (char.): A performance parameter that the product is expected to meet before it leaves the factory, but that is not verified in the field and is not covered by the product warranty. A characteristic includes the same guardbands as a specification.

Corrected (residual): Indicates performance after error correction (calibration). It is determined by the quality of calibration standards and how well "known" they are, plus system repeatability, stability, and noise.

Nominal (nom.): A general, descriptive term that does not imply a level of performance. It is not covered by the product warranty.

Specification (spec.): Warranted performance. Specifications include guardbands to account for the expected statistical performance distribution, measurement uncertainties, and changes in performance due to environmental conditions.

Standard: When referring to the analyzer, this includes no options unless noted otherwise.

Typical (typ.): Expected performance of an average unit, which does not include guardbands. It is not covered by the product warranty.

Uncorrected (raw): Indicates instrument performance without error correction. The uncorrected performance affects the stability of a calibration.

Table of Contents

E8362/3/4B

Corrected system performance.....	4
System dynamic range.....	4
Receiver dynamic range.....	6
Corrected system performance with 2.4 mm connectors.....	7
Corrected system performance with 3.5 mm connectors.....	9
Uncorrected system performance.....	11
Test port output.....	13
Test port input.....	15

E8361A

Corrected system performance.....	20
System dynamic range.....	20
Corrected system performance with 1.85 mm connectors.....	21
Corrected system performance with 2.4 mm connectors.....	29
Uncorrected system performance.....	33
Test port output.....	36
Test port input.....	38

Microwave PNA Series

General information.....	47
Measurement throughput summary.....	50
Cycle time vs. IF bandwidth.....	50
Cycle time vs. number of points.....	50
Cycle time.....	50
Data transfer time.....	51
Frequency Converter Application (Option 083) Cycle Time.....	52
Measurement capabilities.....	53
Source control.....	53
Trace functions.....	53
Automation.....	54
Data accuracy enhancement.....	55
Storage.....	55
System capabilities.....	56
PNA Series simplified test set block diagram....	58
Ordering guide for PNA Series	
Network analyzers.....	60
Test port cable specifications.....	61
Information resources.....	63

E8362/3/4B

Corrected system performance

The specifications in this section apply for measurements made with the Agilent E8362/3/4B PNA Series microwave network analyzer with the following conditions:

- 10 Hz IF bandwidth
- no averaging applied to data
- isolation calibration with an averaging factor of 8

Note: Samples of uncertainty curves are included in this Data Sheet. Please download our free uncertainty calculator (www.agilent.com/find/na_calculator) to generate the curves for your setup.

System dynamic range ¹

Description	Specification (dB) at test port ²	Typical (dB) at direct receiver access input ³	Supplemental information
Dynamic range			
Standard configuration and standard power range (E8362/3/4B)			
10 to 45 MHz ⁴	79	N/A	
45 to 500 MHz ⁵	94	N/A	
500 MHz to 2 GHz	119	N/A	
2 to 10 GHz	122	N/A	
10 to 20 GHz	123	N/A	
20 to 30 GHz	114	N/A	
30 to 40 GHz	110	N/A	
40 to 45 GHz	109	N/A	
45 to 50 GHz	104	N/A	
Extended configuration and standard power range (E8362/3/4B-Option 014)			
10 to 45 MHz ⁴	79	129	
45 to 500 MHz ⁵	94	132	
500 MHz to 2 GHz	119	138	
2 to 10 GHz	122	137	
10 to 20 GHz	121	136	
20 to 30 GHz	111	123	} Option 016 degrades performance by 2 dB
30 to 40 GHz	107	119	
40 to 45 GHz	105	116	
45 to 50 GHz	100	111	

1. The system dynamic range is calculated as the difference between the noise floor and the source maximum output power. System dynamic range is a specification when the source is set to port 1, and a characteristic when the source is set to port 2. The effective dynamic range must take measurement uncertainties and interfering signals into account.
2. The test port system dynamic range is calculated as the difference between the test port noise floor and the source maximum output power. The effective dynamic range must take measurement uncertainties and interfering signals into account.
3. The direct receiver access input system dynamic range is calculated as the difference between the direct receiver access input noise floor and the source

- maximum output power. The effective dynamic range must take measurement uncertainties and interfering signals into account. This set-up should only be used when the receiver input will never exceed its damage level. When the analyzer is in segment sweep mode, the analyzer can have pre-defined frequency segments which will output a higher power level when the extended dynamic range is required (i.e. devices with high insertion loss), and reduced power when receiver damage may occur (i.e. devices with low insertion loss). The extended range is only available in one-path transmission measurements.
4. Typical performance.
 5. May be limited to 100 dB at particular frequencies below 500 MHz due to spurious receiver residuals. Methods are available to regain the full dynamic range.

E8362/3/4B

Corrected system performance *continued*

System dynamic range ¹

Description	Specification (dB) at test port ²	Typical (dB) at direct receiver access input ³	Supplemental information
Dynamic range			
Standard configuration and extended power range and bias-tees (E8362/3/4B-Option UNL)			
10 to 45 MHz ⁴	79	N/A	
45 to 500 MHz ⁵	92	N/A	
500 MHz to 2 GHz	117	N/A	
2 to 10 GHz	120	N/A	
10 to 20 GHz	121	N/A	
20 to 30 GHz	112	N/A	} Option 016 degrades performance by 2 dB
30 to 40 GHz	108	N/A	
40 to 45 GHz	105	N/A	
45 to 50 GHz	99	N/A	
Configurable test set and extended power range and bias-tees (E8362/3/4B-Option UNL and Option 014)			
10 to 45 MHz ⁴	79	129	
45 to 500 MHz ^{5, 6}	92	130	
500 MHz to 2 GHz ⁶	117	136	
2 to 10 GHz ⁶	120	135	
10 to 20 GHz ⁷	119	134	
20 to 30 GHz	109	121	} Option 016 degrades performance by 2 dB
30 to 40 GHz	105	117	
40 to 45 GHz	101	112	
45 to 50 GHz	95	106	

1. The system dynamic range is calculated as the difference between the noise floor and the source maximum output power. System dynamic range is a specification when the source is set to port 1, and a characteristic when the source is set to port 2. The effective dynamic range must take measurement uncertainties and interfering signals into account.

2. The test port system dynamic range is calculated as the difference between the test port noise floor and the source maximum output power. The effective dynamic range must take measurement uncertainties and interfering signals into account.

3. The direct receiver access input system dynamic range is calculated as the difference between the direct receiver access input noise floor and the source maximum output power. The effective dynamic range must take measurement uncertainties and interfering signals into account. This set-up should only be

used when the receiver input will never exceed its damage level. When the analyzer is in segment sweep mode, the analyzer can have pre-defined frequency segments which will output a higher power level when the extended dynamic range is required (i.e. devices with high insertion loss), and reduced power when receiver damage may occur (i.e. devices with low insertion loss). The extended range is only available in one-path transmission measurements.

4. Typical performance.

5. May be limited to 100 dB at particular frequencies below 500 MHz due to spurious receiver residuals. Methods are available to regain the full dynamic range.

6. E8362B only; Option H11 decreases value by 1 dB.

7. E8362B only; Option H11 decreases value by 2 dB.

E8362/3/4B

Receiver dynamic range¹

Description	Specification (dB) at test port ²	Typical (dB) at direct receiver access input ³	Supplemental information
Dynamic range			
Standard configuration and standard power range (E8362/3/4B) or standard configuration and extended power range and bias-tees (E8362/3/4B-Option UNL)			
10 to 45 MHz ⁴	82	N/A	
45 to 500 MHz ⁵	94	N/A	
500 MHz to 2 GHz	119	N/A	
2 to 10 GHz	122	N/A	
10 to 20 GHz	125	N/A	
20 to 30 GHz	114	N/A	Option 016 degrades performance by 2 dB
30 to 40 GHz	111	N/A	Option 016 degrades performance by 2 dB
40 to 50 GHz	111	N/A	Option 016 degrades performance by 2 dB
Configurable test set and standard power range (E8362/3/4B Option 014) or configurable test set and extended power range and bias-tees (E8362/3/4B-Option 014 and Option UNL)			
10 to 45 MHz ⁴	82	132	
45 to 500 MHz ⁵	94	132	
500 MHz to 2 GHz	119	138	
2 to 10 GHz	122	137	
10 to 20 GHz	124	139	
20 to 40 GHz	113	125	Option 016 degrades performance by 2 dB
40 to 45 GHz	110	122	Option 016 degrades performance by 2 dB
45 to 50 GHz	109	120	Option 016 degrades performance by 2 dB

1. The receiver dynamic range is calculated as the difference between the noise floor and the receiver maximum input level. The effective dynamic range must take measurement uncertainties and interfering signals into account.
2. The test port receiver dynamic range is calculated as the difference between the test port noise floor and the receiver maximum input level. The effective dynamic range must take measurement uncertainties and interfering signals into account.
3. The direct receiver access input receiver dynamic range is calculated as the difference between the direct receiver access input noise floor and the receiver maximum input level. The effective dynamic range must take measurement uncertainties and interfering signals into account. This set-up should only be used

- when the receiver input will never exceed its compression or damage level. When the analyzer is in segment sweep mode, the analyzer can have pre-defined frequency segments which will output a higher power level when the extended dynamic range is required (i.e. devices with high insertion loss), and reduced power when compression or receiver damage may occur (i.e. devices with low insertion loss). The extended range is only available in one-path transmission measurements.
4. Typical performance.
 5. May be degraded by 10 dB at particular frequencies (multiples of 5 MHz) below 500 MHz due to spurious receiver residuals. Methods are available to regain the full dynamic range.

E8362/3/4B

Corrected system performance with 2.4 mm connectors

Standard configuration and standard power range (E8363/4B)

Applies to E8363/4B PNA Series analyzer, 85056A (2.4 mm) calibration kit, 85133F flexible test port cable set, and a full two-port calibration. (Specifications apply over environmental temperature of $23\text{ }^{\circ}\text{C} \pm 3\text{ }^{\circ}\text{C}$, with less than $1\text{ }^{\circ}\text{C}$ deviation from calibration temperature.)

Description	Specification (dB)			
	45 MHz to 2 GHz	2 to 20 GHz	20 to 40 GHz	40 to 50 GHz
Directivity	42	42	38	36
Source match	41	38	33	31
Load match	42	42	37	35
Reflection tracking	± 0.001 (+0.02/ $^{\circ}\text{C}$)	± 0.008 (+0.02/ $^{\circ}\text{C}$)	± 0.020 (+0.02/ $^{\circ}\text{C}$)	± 0.027 (+0.03/ $^{\circ}\text{C}$)
Transmission tracking	± 0.010 (+0.02/ $^{\circ}\text{C}$)	± 0.049 (+0.02/ $^{\circ}\text{C}$)	± 0.105 (+0.02/ $^{\circ}\text{C}$)	± 0.170 (+0.03/ $^{\circ}\text{C}$)

Transmission uncertainty (specifications)

Magnitude

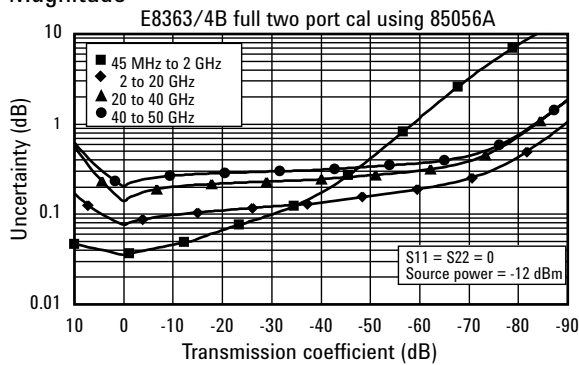

Phase

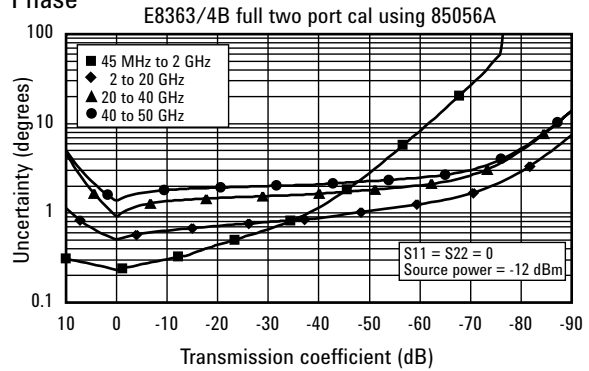

Reflection uncertainty (specifications)

Magnitude

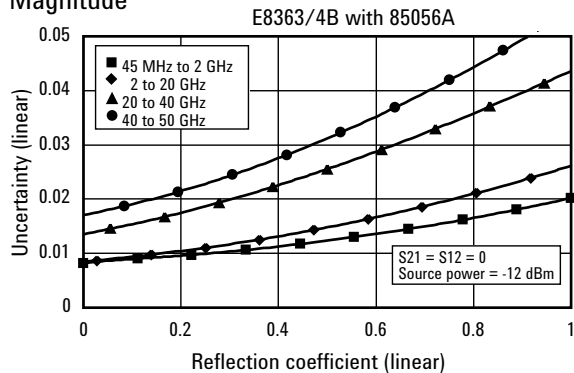

Phase

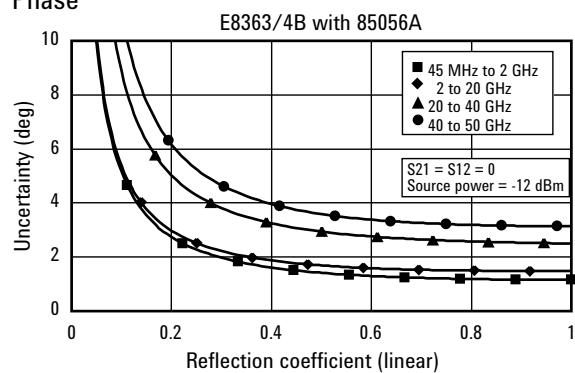

E8362/3/4B

Corrected system performance with 2.4 mm connectors *continued*

Fully Optioned (E8363/4B-Option 014/UNL/080/081/016)

Applies to E8363/4B PNA Series analyzer, 85056A (2.4 mm) calibration kit, 85133F flexible test port cable set, and a full two-port calibration. (Specifications apply over environmental temperature of 23 °C ±3 °C, with less than 1 °C deviation from calibration temperature.)

Description	Specification (dB)			
	45 MHz to 2 GHz	2 to 20 GHz	20 to 40 GHz	40 to 50 GHz
Directivity	42	42	38	36
Source match	41	38	33	31
Load match	42	42	37	35
Reflection tracking	±0.001 (+0.02/°C)	±0.008 (+0.02/°C)	±0.020 (+0.02/°C)	±0.027 (+0.03/°C)
Transmission tracking	±0.019 (+0.02/°C)	±0.053 (+0.02/°C)	±0.109 (+0.02/°C)	±0.182 (+0.03/°C)

Transmission uncertainty (specifications)

Magnitude

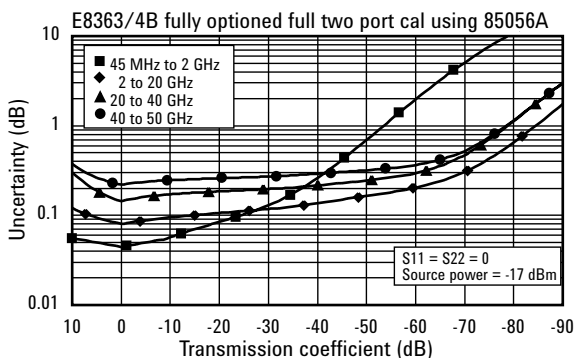

Phase

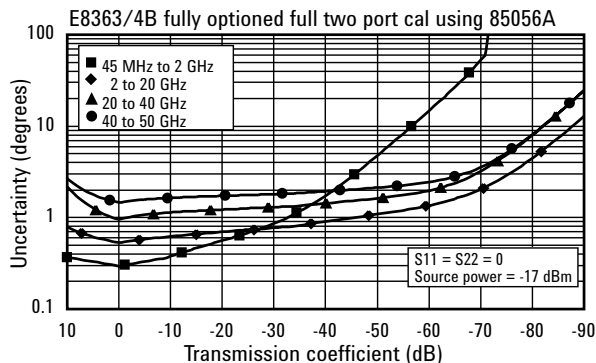

Reflection uncertainty (specifications)

Magnitude

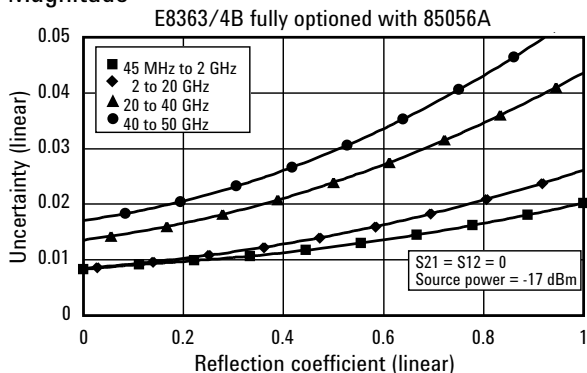

Phase

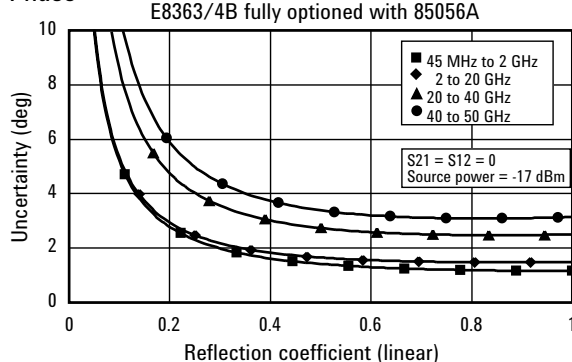

E8362/3/4B

Corrected system performance with 3.5 mm connectors

Standard configuration and standard power range (E8362B)

Applies to E8362B PNA Series analyzer, 85052B (3.5 mm) calibration kit, 85131F flexible test port cable set, and a full two-port calibration. (Specifications apply over environmental temperature of 23 °C ±3 °C, with less than 1 °C deviation from calibration temperature.)

Description	Specification (dB)		
	45 MHz to 2 GHz	2 to 20 GHz	2 to 26.5 GHz
Directivity	48	44	44
Source match	40	31	31
Load match	48	44	44
Reflection tracking	±0.003 (+0.02/°C)	±0.006 (+0.02/°C)	±0.006 (+0.03/°C)
Transmission tracking	±0.009 (+0.02/°C)	±0.088 (+0.02/°C)	±0.104 (+0.03/°C)

Transmission uncertainty (specifications)

Magnitude

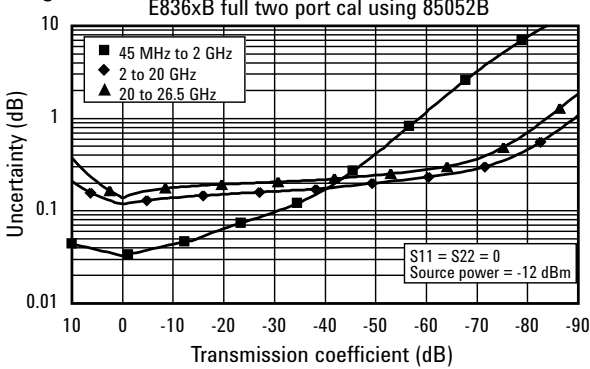

Phase

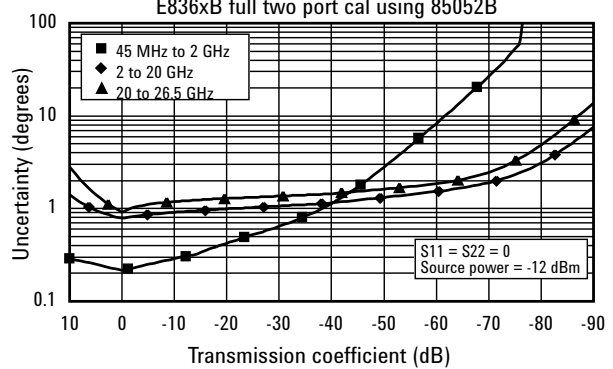

Reflection uncertainty (specifications)

Magnitude

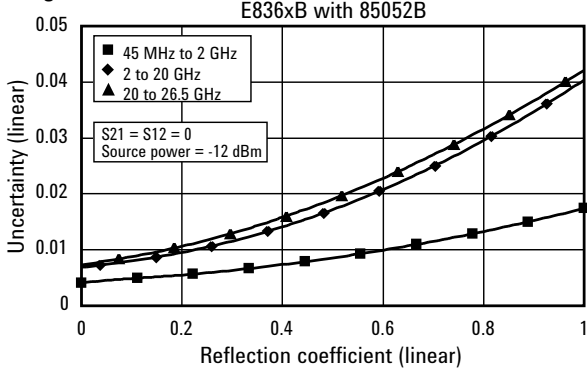

Phase

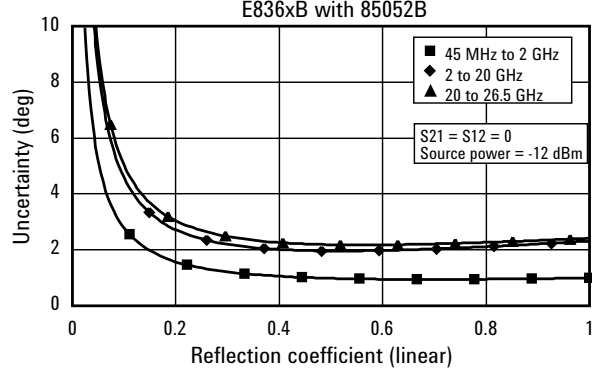

E8362/3/4B

Corrected system performance with 3.5 mm connectors *continued*

Fully Optioned (E8362B-Option 014/UNL/080/081/016)

Applies to E8362B PNA Series analyzer, 85052B (3.5 mm) calibration kit, 85131F flexible test port cable set, and a full two-port calibration. (Specifications apply over environmental temperature of 23 °C ±3 °C, with less than 1 °C deviation from calibration temperature.)

Description	Specification (dB)		
	45 MHz to 2 GHz	2 to 20 GHz	20 to 26.5 GHz
Directivity	48	44	44
Source match	40	31	31
Load match	48	44	44
Reflection tracking	±0.003 (+0.02/°C)	±0.006 (+0.02/°C)	±0.006 (+0.03/°C)
Transmission tracking	±0.017 (+0.02/°C)	±0.091 (+0.02/°C)	±0.106 (+0.03/°C)

Transmission uncertainty (specifications)

Magnitude

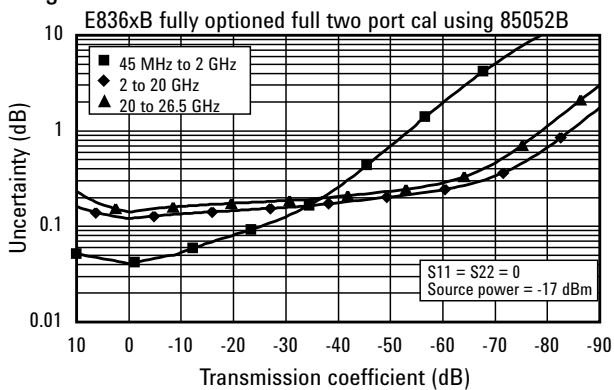

Phase

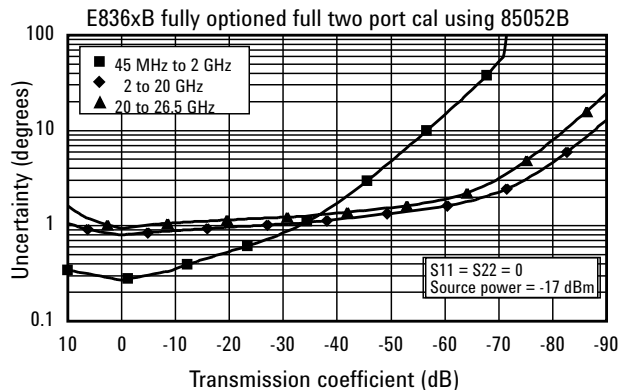

Reflection uncertainty (specifications)

Magnitude

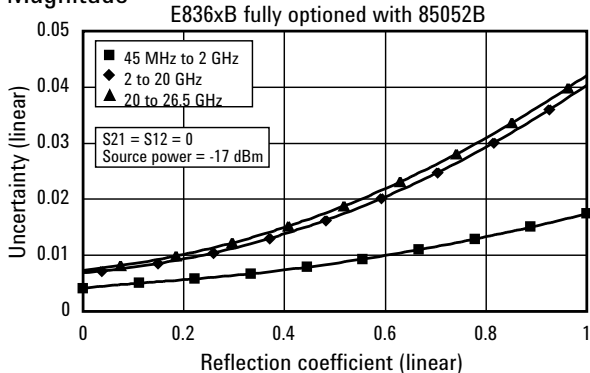

Phase

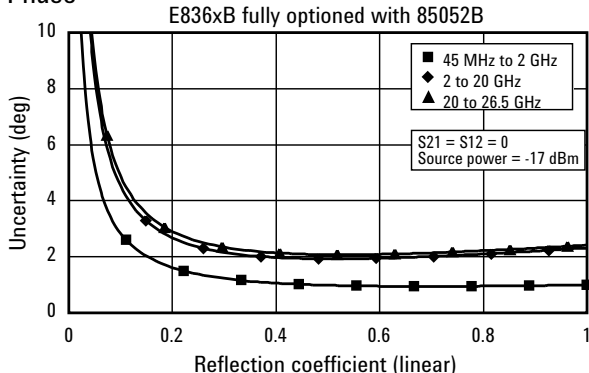

E8362/3/4B

Uncorrected system performance ¹

Description	Specification	Supplemental information
Directivity		
10 to 45 MHz ²	23 dB	Typical: 23 dB
45 MHz to 2 GHz	24 dB	29 dB
2 to 10 GHz	22 dB	25 dB
10 to 20 GHz	16 dB	20 dB
20 to 40 GHz	16 dB	20 dB
40 to 45 GHz	15 dB	18 dB
45 to 50 GHz	13 dB	18 dB
Source match - standard		
10 to 45 MHz ²	11 dB	Typical: 12 dB
45 MHz to 2 GHz	23 dB	27 dB
2 to 10 GHz	16 dB	19 dB
10 to 20 GHz	14 dB	19 dB
20 to 40 GHz	10 dB	14 dB
40 to 45 GHz	9 dB	13.5 dB
45 to 50 GHz	7.5 dB	10 dB
Source match - Option UNL, 014, or UNL and 014		
10 to 45 MHz ²	11 dB	Typical: 12 dB
45 MHz to 2 GHz	18 dB	22.5 dB
2 to 10 GHz	14 dB	18 dB
10 to 20 GHz	12 dB	15 dB
20 to 40 GHz	9 dB	11 dB
40 to 45 GHz	8 dB	13 dB
45 to 50 GHz	6 dB	9 dB
Load match - standard		
10 to 45 MHz ²	11 dB	Typical: 12 dB
45 MHz to 2 GHz	23 dB	29 dB
2 to 10 GHz	14 dB	16 dB
10 to 20 GHz	10 dB	12 dB
20 GHz to 40 GHz	9 dB	12 dB
40 to 45 GHz	9 dB	13 dB
45 to 50 GHz	8 dB	10 dB
Load match - Option UNL, 014, or UNL and 014		
10 to 45 MHz ²	11 dB	Typical: 12 dB
45 MHz to 2 GHz	17 dB	21.5 dB
2 to 10 GHz	13 dB	16.5 dB
10 to 20 GHz	10 dB	13 dB
20 to 40 GHz	9 dB	11 dB
40 to 45 GHz	9 dB	13 dB
45 to 50 GHz	7 dB	9.5 dB
Reflection tracking		
10 to 45 MHz ²		Typical: ±1.5 dB
45 MHz to 20 GHz		±1.5 dB
20 to 40 GHz		±1.5 dB
40 to 50 GHz		±2.0 dB
Transmission tracking³		
10 to 45 MHz ²		Typical: ±3.0 dB
45 MHz to 2 GHz		±1.5 dB
2 to 10 GHz		±2.0 dB
10 to 20 GHz		±2.5 dB
20 to 40 GHz		±3.5 dB
40 to 45 GHz		±4.0 dB
45 to 50 GHz		±4.5 dB

1. Specifications apply over environment temperature of 23 °C ±3 °C, with less than 1 °C deviation from the calibration temperature.

2. Typical performance.

3. Transmission tracking performance is strongly dependent on cable used. These typical specifications are based on the use of an Agilent through cable, part number 85133-60016.

E8362/3/4B

Uncorrected system performance ¹ *continued*

Description	Specification	Supplemental information
Crosstalk¹ - standard		
10 to 45 MHz ²	65 dB	
45 MHz to 1 GHz	85 dB	
1 to 2 GHz	100 dB	
2 to 20 GHz	110 dB	
20 to 40 GHz	108 dB	
40 to 45 GHz	105 dB	
45 to 50 GHz	100 dB	
Crosstalk¹ - Option UNL or 014		
10 to 45 MHz ²	65 dB	
45 MHz to 1 GHz	85 dB	
1 to 2 GHz	100 dB	
2 to 20 GHz	109 dB	
20 to 40 GHz	106 dB	
40 to 45 GHz	103 dB	
45 to 50 GHz	98 dB	
Crosstalk¹ - Option UNL and 014		
10 to 45 MHz ²	65 dB	
45 MHz to 1 GHz	85 dB	
1 to 2 GHz	98 dB	
2 to 10 GHz	108 dB	
10 to 20 GHz	107 dB	
20 to 40 GHz	104 dB	
40 to 45 GHz	100 dB	
45 to 50 GHz	95 dB	
Crosstalk - Option 080 enabled³		Typical:
10 to 45 MHz		65 dB
45 MHz to 1 GHz		85 dB
1 to 2 GHz		100 dB
2 to 10 GHz		109 dB
10 to 20 GHz		110 dB
20 to 40 GHz		106 dB
40 to 45 GHz		103 dB
45 to 50 GHz		98 dB

1. Measurement conditions: Normalized to a thru, measured with two shorts, 10 Hz IF bandwidth, averaging factor of 16, alternate mode, source power set to the lesser of the maximum power out or the maximum receiver power.

2. Typical performance.

3. 0 Hz offset.

E8362/3/4B

Test port output

Description	Specification				Supplemental information
	Standard	014	UNL	UNL and 014	
Frequency range					
E8362B	----- 10 MHz to 20 GHz-----				
E8363B	----- 10 MHz to 40 GHz-----				
E8364B	----- 10 MHz to 50 GHz-----				
Nominal power ²					
E8362B	0 dBm	-5 dBm	-5 dBm	-5 dBm	
E8363/4B	-12 dBm	-17 dBm	-17 dBm	-17 dBm	
Frequency resolution	1 Hz	1 Hz	1 Hz	1 Hz	
CW accuracy	± 1ppm	± 1ppm	± 1ppm	± 1ppm	
Frequency stability					±1 ppm, 0 to 40 °C, typical ±0.2 ppm/yr, typical
Power level accuracy ¹					
10 to 45 MHz ³	±2.0 dB	±2.0 dB	±2.0 dB	±2.0 dB	Variation from nominal power in range 0 (step attenuator at 0 dB).
45 MHz to 10 GHz	±1.5 dB	±1.5 dB	±1.5 dB	±1.5 dB	
10 to 20 GHz	±2.0 dB	±2.0 dB	±2.0 dB	±2.0 dB	
20 to 40 GHz	±3.0 dB	±3.0 dB	±3.0 dB	±3.0 dB	
40 to 45 GHz	±3.0 dB	±3.5 dB	±3.0 dB	±3.5 dB	
45 to 50 GHz	±3.0 dB	±4.0 dB	±3.0 dB	±4.0 dB	
Power level linearity ⁶					
10 to 45 MHz ³	±1.0 dB ⁴	±1.0 dB ⁴	±1.0 dB ⁴	±1.0 dB ⁴	Test reference is at the nominal power level (step attenuator at 0 dB).
45 MHz to 20 GHz	±1.0 dB ⁴	±1.0 dB ⁴	±1.0 dB ⁴	±1.0 dB ⁴	
20 to 40 GHz	±1.0 dB ⁴	±1.0 dB ⁴	±1.0 dB ⁴	±1.0 dB ⁴	
40 to 50 GHz	±1.0 dB ⁴	±1.0 dB ⁴	±1.0 dB ⁴	±1.0 dB ⁴	
Power range ^{1, 5, 7}					
10 to 45 MHz ³	-25 to +2 dB	-25 to +2 dBm	-87 to +2 dBm	-87 to +2 dBm	
45 MHz to 10 GHz	-25 to +5 dB	-25 to +5 dBm	-87 to +3 dBm	-87 to +3 dBm ⁸	
10 to 20 GHz	-24 to +3 dB	-25 to +2 dBm	-86 to +1 dBm	-87 to 0 dBm ⁹	
20 to 30 GHz	-23 to 0 dBm	-25 to -2 dBm	-85 to -2 dBm	-87 to -4 dBm	
30 to 40 GHz	-23 to -4 dBm	-25 to -6 dBm	-85 to -6 dBm	-87 to -8 dBm	
40 to 45 GHz	-25 to -5 dBm	-27 to -7 dBm	-87 to -9 dBm	-87 to -11 dBm	
45 to 50 GHz	-25 to -10 dBm	-27 to -12 dBm	-87 to -15 dBm	-87 to -17 dBm	
Power sweep range (ALC)					
10 to 45 MHz ³	27 dB	27 dB	29 dB	29 dB	ALC range starts at maximum leveled output power and decreases by power level indicated in the table.
45 MHz to 10 GHz	30 dB	30 dB	30 dB	30 dB ¹⁰	
10 to 20 GHz	27 dB	27 dB	27 dB	27 dB ¹¹	
20 to 30 GHz	23 dB	23 dB	23 dB	23 dB	
30 to 40 GHz	19 dB	19 dB	19 dB	19 dB	
40 to 45 GHz	20 dB	20 dB	18 dB	16 dB	
45 to 50 GHz	15 dB	15 dB	12 dB	10 dB	
Power resolution	0.01 dB	0.01 dB	0.01 dB	0.01 dB	

- Test port output is a specification when the source is set to port 1 and a characteristic when the source is set to port 2.
- Preset power.
- Typical performance.
- ±1.5 dB for power ≤ -23 dBm.
- Power to which the source can be set and phase lock is assured.
- Power level linearity is a specification when the source is set to port 1 and a typical when the source is set to port 2.
- Test port power is specified into nominal 50 ohms.
- Option H11 decreases maximum power level by 1 dB.
- Option H11 decreases maximum power level by 2 dB.
- Option H11 decreases power level by 1 dB.
- Option H11 decreases power level by 2 dB.

E8362/3/4B

Test port output *continued*

Description	Specification	Supplemental information
Phase noise (1 kHz offset from center frequency, nominal power at test port)		
10 MHz to 10 GHz		-60 dBc typical
10 to 20 GHz		-55 dBc typical
20 to 50 GHz		-50 dBc typical
Phase noise (1 kHz offset from center frequency, nominal power at test port) – Option 080 enabled		
10 MHz to 10 GHz		-60 dBc typical
10 to 20 GHz		-60 dBc typical
20 to 50 GHz		-50 dBc typical
Phase noise (10 kHz offset from center frequency, nominal power at test port)		
10 to 45 MHz		-70 dBc typical
45 MHz to 10 GHz		-70 dBc typical
10 to 20 GHz		-65 dBc typical
20 to 40 GHz		-55 dBc typical
40 to 50 GHz		-55 dBc typical
Phase noise (10 kHz offset from center frequency, nominal power at test port) – Option 080 enabled		
10 to 45 MHz		-70 dBc typical
45 MHz to 10 GHz		-70 dBc typical
10 to 20 GHz		-65 dBc typical
20 to 40 GHz		-55 dBc typical
40 to 50 GHz		-55 dBc typical
Phase noise (100 kHz offset from center frequency, nominal power at test port)		
10 MHz to 10 GHz		-60 dBc typical
10 to 20 GHz		-55 dBc typical
20 to 50 GHz		-50 dBc typical
Phase noise (100 kHz offset from center frequency, nominal power at test port) – Option 080 enabled		
10 MHz to 10 GHz		-75 dBc typical
10 to 20 GHz		-70 dBc typical
20 to 50 GHz		-65 dBc typical
Phase noise (1 MHz offset from center frequency, nominal power at test port)		
10 MHz to 10 GHz		-106 dBc typical
10 to 20 GHz		-103 dBc typical
20 to 50 GHz		-90 dBc typical
Phase noise (1 MHz offset from center frequency, nominal power at test port) – Option 080 enabled		
10 MHz to 10 GHz		-103 dBc typical
10 to 20 GHz		-97 dBc typical
20 to 50 GHz		-85 dBc typical
Harmonics (2nd or 3rd)		-23 dBc typical, in power range 0
Non-harmonic spurious (at nominal output power)		
10 to 45 MHz		-50 dBc typical, for offset frequency > 1 kHz
45 MHz to 20 GHz		-50 dBc typical, for offset frequency > 1 kHz
20 to 40 GHz		-30 dBc typical, for offset frequency > 1 kHz
40 to 50 GHz		-30 dBc typical, for offset frequency > 1 kHz

1. Source output performance on port 1 only. Port 2 output performance is typical, except for power level accuracy which is characteristic.

E8362/3/4B

Test port input

Description	Specification				Supplemental information
	Standard	014	UNL	UNL and 014	
Test port noise floor¹					
10 Hz IF bandwidth					
10 to 45 MHz ²	< -77 dBm	< -77 dBm	< -77 dBm	< -77 dBm	
45 to 500 MHz ³	< -89 dBm	< -89 dBm	< -89 dBm	< -89 dBm	
500 MHz to 2 GHz	< -114 dBm	< -114 dBm	< -114 dBm	< -114 dBm	
2 to 10 GHz	< -117 dBm	< -117 dBm	< -117 dBm	< -117 dBm	
10 to 20 GHz	< -120 dBm	< -119 dBm	< -120 dBm	< -119 dBm	
20 to 40 GHz	< -114 dBm	< -113 dBm	< -114 dBm	< -113 dBm	Option 016 degrades performance by 2 dB
40 to 50 GHz	< -114 dBm	< -112 dBm	< -114 dBm	< -112 dBm	Option 016 degrades performance by 2 dB
1 kHz IF bandwidth					
10 to 45 MHz ²	< -57 dBm	< -57 dBm	< -57 dBm	< -57 dBm	
45 to 500 MHz ³	< -69 dBm	< -69 dBm	< -69 dBm	< -69 dBm	
500 MHz to 2 GHz	< -94 dBm	< -94 dBm	< -94 dBm	< -94 dBm	
2 to 10 GHz	< -97 dBm	< -97 dBm	< -97 dBm	< -97 dBm	
10 to 20 GHz	< -100 dBm	< -99 dBm	< -100 dBm	< -99 dBm	
20 to 40 GHz	< -94 dBm	< -93 dBm	< -94 dBm	< -93 dBm	Option 016 degrades performance by 2 dB
40 to 50 GHz	< -94 dBm	< -92 dBm	< -94 dBm	< -92 dBm	Option 016 degrades performance by 2 dB
Test port noise floor^{1,2} - Option 080 enabled⁴					
10 Hz IF bandwidth					
10 to 45 MHz ²	< -77 dBm	< -77 dBm	< -77 dBm	< -77 dBm	
45 to 500 MHz ³	< -88 dBm	< -88 dBm	< -88 dBm	< -88 dBm	
500 MHz to 2 GHz	< -113 dBm	< -113 dBm	< -113 dBm	< -113 dBm	
2 to 10 GHz	< -116 dBm	< -116 dBm	< -116 dBm	< -116 dBm	
10 to 20 GHz	< -118 dBm	< -118 dBm	< -118 dBm	< -118 dBm	
20 to 40 GHz	< -112 dBm	< -112 dBm	< -112 dBm	< -112 dBm	Option 016 degrades performance by 2 dB
40 to 50 GHz	< -111 dBm	< -111 dBm	< -111 dBm	< -111 dBm	Option 016 degrades performance by 2 dB
1 kHz IF bandwidth					
10 to 45 MHz ²	< -57 dBm	< -57 dBm	< -57 dBm	< -57 dBm	
45 to 500 MHz ³	< -68 dBm	< -68 dBm	< -68 dBm	< -68 dBm	
500 MHz to 2 GHz	< -93 dBm	< -93 dBm	< -93 dBm	< -93 dBm	
2 to 10 GHz	< -96 dBm	< -96 dBm	< -96 dBm	< -96 dBm	
10 to 20 GHz	< -98 dBm	< -98 dBm	< -98 dBm	< -98 dBm	
20 to 40 GHz	< -92 dBm	< -92 dBm	< -92 dBm	< -92 dBm	Option 016 degrades performance by 2 dB
40 to 50 GHz	< -91 dBm	< -91 dBm	< -91 dBm	< -91 dBm	Option 016 degrades performance by 2 dB
Direct receiver access input noise floor^{1,2}					
10 Hz IF bandwidth					
10 to 45 MHz		< -127 dBm		< -127 dBm	
45 to 500 MHz		< -127 dBm		< -127 dBm	
500 MHz to 2 GHz		< -133 dBm		< -133 dBm	
2 to 10 GHz		< -132 dBm		< -132 dBm	
10 to 20 GHz		< -134 dBm		< -134 dBm	
20 to 40 GHz		< -125 dBm		< -125 dBm	Option 016 degrades performance by 2 dB
40 to 50 GHz		< -123 dBm		< -123 dBm	Option 016 degrades performance by 2 dB
1 kHz IF bandwidth					
10 to 45 MHz		< -107 dBm		< -107 dBm	
45 to 500 MHz		< -107 dBm		< -107 dBm	
500 MHz to 2 GHz		< -113 dBm		< -113 dBm	
2 to 10 GHz		< -112 dBm		< -112 dBm	
10 to 20 GHz		< -114 dBm		< -114 dBm	
20 to 40 GHz		< -105 dBm		< -105 dBm	Option 016 degrades performance by 2 dB
40 to 50 GHz		< -103 dBm		< -103 dBm	Option 016 degrades performance by 2 dB

1. Total average (rms) noise power calculated as mean value of a linear magnitude trace expressed in dBm.

2. Typical performance.

3. Noise floor may be degraded by 10 dB at particular frequencies (multiples of 5 MHz) due to spurious receiver residuals.

4. 0 Hz offset.

E8362/3/4B

Test port input *continued*

Description	Specification		Supplemental information
	Standard, 014, UNL	UNL and 014	
Direct receiver access input noise floor^{1,2} - Option 080 enabled⁴			
10 Hz IF bandwidth			
10 to 45 MHz	< -127 dBm	< -127 dBm	
45 to 500 MHz ³	< -126 dBm	< -126 dBm	
500 MHz to 2 GHz	< -132 dBm	< -132 dBm	
2 to 10 GHz	< -131 dBm	< -131 dBm	
10 to 20 GHz	< -133 dBm	< -133 dBm	
20 to 40 GHz	< -124 dBm	< -124 dBm	Option 016 degrades performance by 2 dB
40 to 50 GHz	< -122 dBm	< -122 dBm	Option 016 degrades performance by 2 dB
1 kHz IF bandwidth			
10 to 45 MHz	< -107 dBm	< -107 dBm	
45 to 500 MHz ³	< -106 dBm	< -106 dBm	
500 MHz to 2 GHz	< -112 dBm	< -112 dBm	
2 to 10 GHz	< -111 dBm	< -111 dBm	
10 to 20 GHz	< -113 dBm	< -113 dBm	
20 to 40 GHz	< -104 dBm	< -104 dBm	Option 016 degrades performance by 2 dB
40 to 50 GHz	< -102 dBm	< -102 dBm	Option 016 degrades performance by 2 dB
Receiver compression level (measured at test ports)			
10 MHz to 20 GHz	----- < 0.1 dB at -5 dBm ⁵ and < 0.45 dB at +5 dBm		
20 to 30 GHz	----- < 0.1 dB at -9.5 dBm ⁵ and < 0.45 dB at 0 dBm		
30 to 40 GHz	----- < 0.1 dB at -12.5 dBm ⁵ and < 0.45 dB at -3 dBm		
40 to 50 GHz	----- < 0.1 dB at -12.5 dBm ⁵ and < 0.45 dB at -3 dBm		
System compression level	max output power		See dynamic accuracy chart
Third order intercept – Tone spacing from 100 kHz to 5 MHz			
10 to 150 MHz			Typical: +33 dBm
150 to 300 MHz			+34 dBm
300 to 500 MHz			+30 dBm
500 MHz to 20 GHz			+24 dBm
20 to 40 GHz			+18 dBm
40 to 50 GHz			+15 dBm
Third order intercept – Tone spacing from 5 MHz to 20 MHz			
10 to 500 MHz			Typical: +20 dBm
500 MHz to 20 GHz			+20 dBm
20 to 40 GHz			+16 dBm
40 to 50 GHz			+15 dBm
Third order intercept – Tone spacing from 20 MHz to 50 MHz			
10 to 500 MHz			Typical: +26 dBm
500 MHz to 20 GHz			+26 dBm
20 to 40 GHz			+20 dBm
40 to 50 GHz			+19 dBm

1. Total average (rms) noise power calculated as mean value of a linear magnitude trace expressed in dBm.

2. Typical performance.

3. Noise floor may be degraded by 10 dB at particular frequencies (multiples of 5 MHz) due to spurious receiver residuals.

4. 0 Hz offset.

5. This compression level comes from the dynamic accuracy curve with -30 dB reference test port power.

E8362/3/4B

Test port input *continued*

Description	Specification				Supplemental information
	Standard	014	UNL	UNL and 014	
Trace noise magnitude					
10 to 45 MHz ¹	-----	< 0.050 dB rms	-----		1 kHz IF bandwidth Ratio measurement, nominal power at test port
45 to 500 MHz ²	-----	< 0.010 dB rms	-----		
500 MHz to 20 GHz	-----	< 0.006 dB rms	-----		
20 to 40 GHz	-----	< 0.006 dB rms	-----		
40 to 50 GHz	-----	< 0.006 dB rms	-----		
Trace noise magnitude – Option 080 enabled^{1, 4}					
10 to 45 MHz ¹	-----	< 0.060 dB rms	-----		1 kHz IF bandwidth Ratio measurement, nominal power at test port
45 to 500 MHz ²	-----	< 0.010 dB rms	-----		
500 MHz to 20 GHz	-----	< 0.006 dB rms	-----		
20 to 40 GHz	-----	< 0.007 dB rms	-----		
40 to 50 GHz	-----	< 0.008 dB rms	-----		
Trace noise phase					
10 to 45 MHz ¹	-----	< 0.350° rms	-----		1 kHz IF bandwidth Ratio measurement, nominal power at test port
45 to 500 MHz ²	-----	< 0.100° rms	-----		
500 MHz to 20 GHz	-----	< 0.060° rms	-----		
20 to 40 GHz	-----	< 0.100° rms	-----		
40 to 50 GHz	-----	< 0.100° rms	-----		
Trace noise phase – Option 080 enabled^{1, 4}					
10 to 45 MHz ¹	-----	< 0.350° rms	-----		1 kHz IF bandwidth Ratio measurement, nominal power at test port
45 to 500 MHz ²	-----	< 0.100° rms	-----		
500 MHz to 20 GHz	-----	< 0.060° rms	-----		
20 to 40 GHz	-----	< 0.100° rms	-----		
40 to 50 GHz	-----	< 0.100° rms	-----		
Reference level magnitude					
Range	±200 dB	±200 dB	±200 dB	±200 dB	
Resolution	0.001 dB	0.001 dB	0.001 dB	0.001 dB	
Reference level phase					
Range	±500°	±500°	±500°	±500°	
Resolution	0.01°	0.01°	0.01°	0.01°	
Stability magnitude³					
10 to 45 MHz					Typical ratio measurement: Measured at the test port ±0.05 dB/°C ±0.02 dB/°C ±0.03 dB/°C ±0.04 dB/°C
45 MHz to 20 GHz					
20 to 40 GHz					
40 to 50 GHz					
Stability phase³					
10 to 45 MHz					Typical ratio measurement: Measured at the test port ±0.5°/°C ±0.2°/°C ±0.5°/°C ±0.8°/°C
45 MHz to 20 GHz					
20 to 40 GHz					
40 to 50 GHz					
Damage input level					
Test port 1 and 2					30 dBm or ±40 VDC, typical 15 dBm or ±15 VDC, typical 15 dBm or ±15 VDC, typical 30 dBm or ±40 VDC, typical
R1, R2 in					
A, B in					
Coupler thru (Option 014 or UNL and 014)					
Coupler arm (Option 014 or UNL and 014)					30 dBm or ±7 VDC, typical 20 dBm or ±15 VDC, typical 20 dBm or 0 VDC, typical
Source out (reference)					
Source out (test ports)					

1. Typical performance.

2. Trace noise magnitude may be degraded to 20 mdB rms at harmonic frequencies of the first IF (8.33 MHz) below 80 MHz.

3. Stability is defined as a ratio measurement measured at the test port.

4. 0 Hz offset.

E8362/3/4B

Test port input *continued*

Group delay ¹

Description	Specification	Supplemental information (typical)
Aperture (selectable)		(frequency span)/(number of points – 1)
Maximum aperture		20% of frequency span
Range		0.5 x (1/minimum aperture)
Maximum delay		Limited to measuring no more than 180° of phase change within the minimum aperture.

The following graph shows characteristic group delay accuracy with type-N full 2-port calibration and a 10 Hz IF bandwidth. Insertion loss is assumed to be less than 2 dB and electrical length to be 10 m.

Group delay (typical)

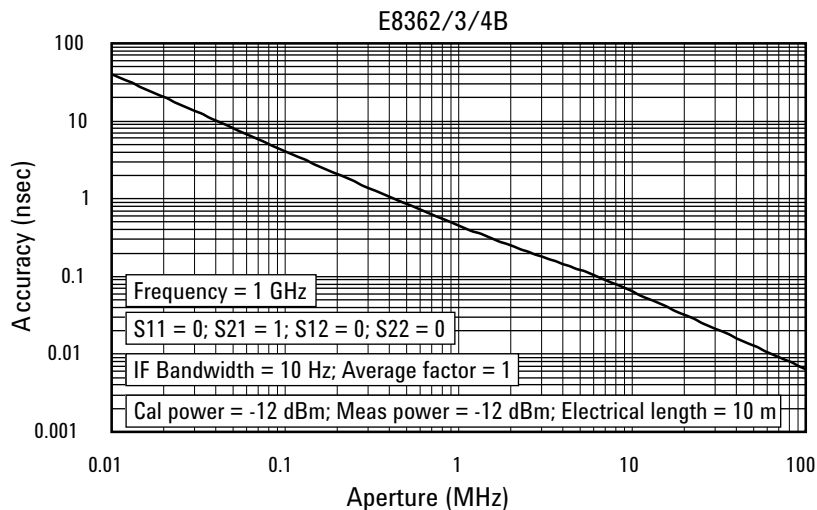

In general, the following formula can be used to determine the accuracy, in seconds, of a specific group delay measurement:

$$\pm \text{Phase accuracy (deg)} / [360 \times \text{Aperture (Hz)}]$$

Depending on the aperture and device length, the phase accuracy used is either incremental phase accuracy or worse case phase accuracy.

1. Group delay is computed by measuring the phase change within a specified frequency step (determined by the frequency span and the number of points per sweep).

E8362/3/4B

Test port input *continued*

Dynamic accuracy (specifications) ¹

Applies to input ports 1 and 2, accuracy of the test port input power reading relative to the reference

input power level. Also applies to the following conditions:

- IF bandwidth = 10 Hz

Magnitude

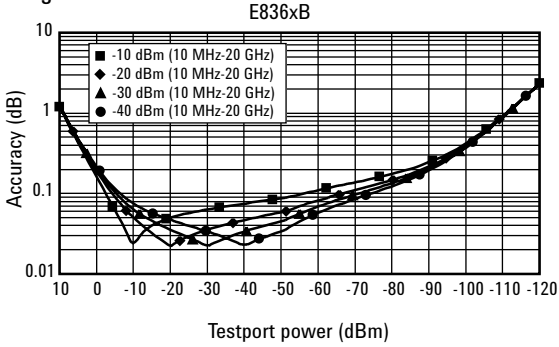

Phase

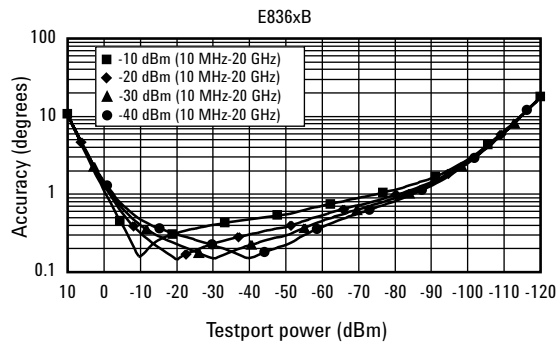

Magnitude

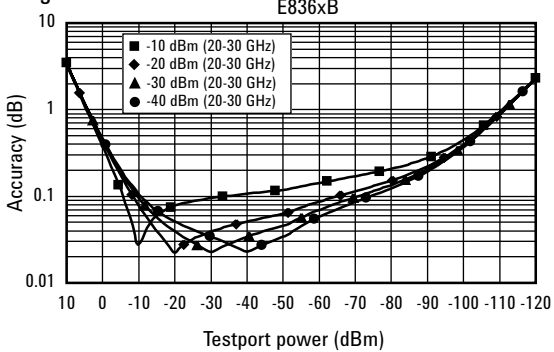

Phase

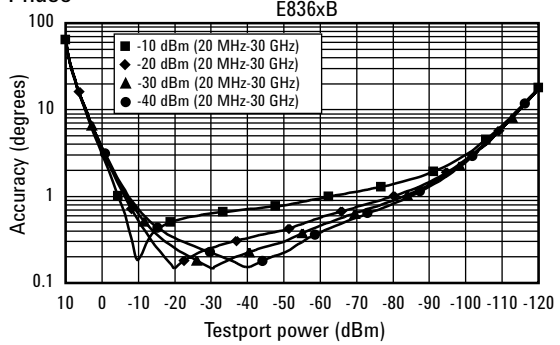

Magnitude

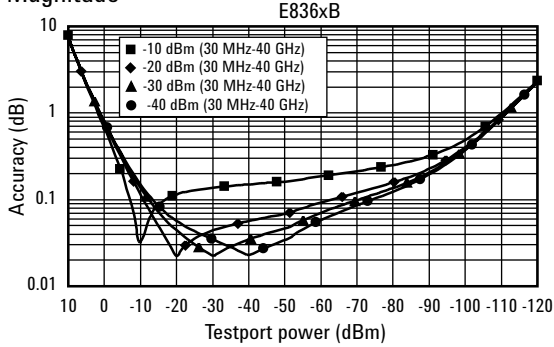

Phase

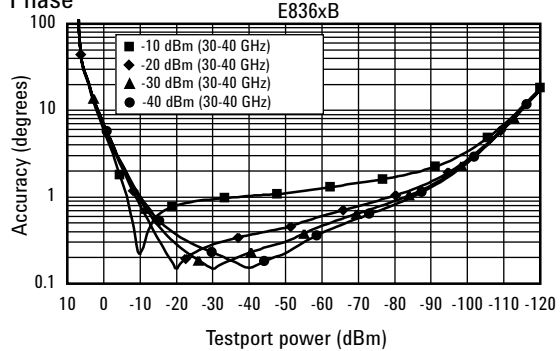

Magnitude

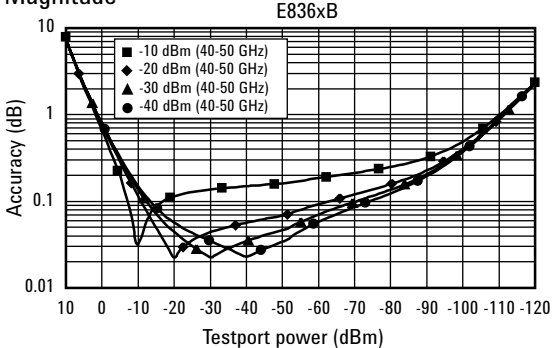

Phase

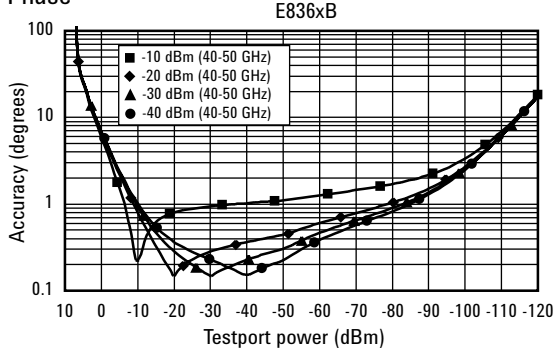

1. Dynamic accuracy is verified with the following measurements: compression over frequency, IF linearity at a single frequency of 1.195 GHz and a reference level of -20 dBm for an input power range of 0 to -120 dBm.

E8361A

Corrected system performance

The specifications in this section apply for measurements made with the Agilent E8361A PNA Series microwave network analyzer with the following conditions:

- 10 Hz IF bandwidth
- no averaging applied to data

System dynamic range ¹

Description	Specification (dB) at test port ²	Typical (dB) at direct receiver access input ³	Supplemental information
Dynamic range			
Standard configuration (E8361A)			
10 to 45 MHz ⁴	61	N/A	
45 to 500 MHz ⁵	87	N/A	
500 to 750 MHz	112	N/A	
750 MHz to 2 GHz	111	N/A	
2 to 10 GHz	111	N/A	
10 to 24 GHz	114	N/A	
24 to 30 GHz	103	N/A	
30 to 40 GHz	104	N/A	
40 to 45 GHz	96	N/A	
45 to 50 GHz	100	N/A	
50 to 60 GHz	97	N/A	
60 to 67 GHz	94	N/A	
67 to 70 GHz ⁴	94	N/A	
Configurable test set (E8361A - Option 014 or Option 014 and 080)			
10 to 45 MHz ⁴	61	99	
45 to 500 MHz ⁵	87	102	
500 to 750 MHz	112	125.5	
750 MHz to 2 GHz	111	125.5	
2 to 10 GHz	111	125	
10 to 24 GHz	112	128	
24 to 30 GHz	101	117.5	} Option 016 degrades performance by 2 dB
30 to 40 GHz	102	115	
40 to 45 GHz	94	109	
45 to 50 GHz	98	110.5	
50 to 60 GHz	95	107	} Option 016 degrades performance by 3 dB
60 to 67 GHz	90	101	
67 to 70 GHz ⁴	90	100	
Configurable test set with extended power range (E8361A - Option 014 and UNL or Options 014, UNL and 080)			
10 to 45 MHz ⁴	61	99	
45 to 500 MHz	87	102	
500 to 750 MHz	112	125.5	
750 MHz to 2 GHz	111	124	
2 to 10 GHz	111	124	
10 to 24 GHz	112	125	
24 to 30 GHz	101	114.5	} Option 016 degrades performance by 2 dB
30 to 40 GHz	99	112	
40 to 45 GHz	92	105	
45 to 50 GHz	94	106.5	
50 to 60 GHz	91	103	} Option 016 degrades performance by 3 dB
60 to 67 GHz	84	95	
67 to 70 GHz ⁴	84	94	

1. The system dynamic range is calculated as the difference between the noise floor and the source maximum output power. System dynamic range is a specification when the source is set to port 1, and a characteristic when the source is set to port 2. The effective dynamic range must take measurement uncertainties and interfering signals into account, as well as the insertion loss resulting from a thru cable connected between port 1 and port 2.
2. The test port system dynamic range is calculated as the difference between the test port noise floor and the source maximum output power. The effective dynamic range must take measurement uncertainties and interfering signals into account, as well as the insertion loss resulting from a thru cable connected between port 1 and port 2.
3. The direct receiver access input system dynamic range is calculated as the difference between the direct receiver access input noise floor and the source maximum output power. The effective dynamic range must take measurement uncertainties and interfering signals into account. This set-up should only be used when the receiver input will never exceed its damage level. When the analyzer is in segment sweep mode, the analyzer can have pre-defined frequency segments which will output a higher power level when the extended dynamic range is required (i.e. devices with high insertion loss), and reduced power when receiver damage may occur (i.e. devices with low insertion loss). The extended range is only available in one-path transmission measurements.
4. Typical performance.
5. May be limited to 100 dB at particular frequencies below 500 MHz due to spurious receiver residuals. Methods are available to regain the full dynamic range.

E8361A

Corrected system performance with 1.85 mm connectors

Standard configuration and standard power range

Applies to E8361A PNA Series analyzer, N4694A (1.85 mm) ECal electronic calibration module, N4697E/F flexible test port cable set, and a full two-port calibration. (Specifications apply over environmental temperature of 23 °C ±3 °C, with less than 1 °C deviation from calibration temperature.)

Description	Specification (dB)			
	10 to 200 MHz ¹	200 MHz to 2 GHz	2 to 20 GHz	20 to 30 GHz
Directivity	33	33	50	46
Source match	25	25	39	35
Load match	25	25	38	34
Reflection tracking	±0.50 (+0.02/°C)	±0.05 (+0.02/°C)	±0.040 (+0.02/°C)	±0.05 (+0.02/°C)
Transmission tracking	±0.152 (+0.02/°C)	±0.152 (+0.02/°C)	±0.050 (+0.02/°C)	±0.069 (+0.02/°C)

Transmission uncertainty (specifications)

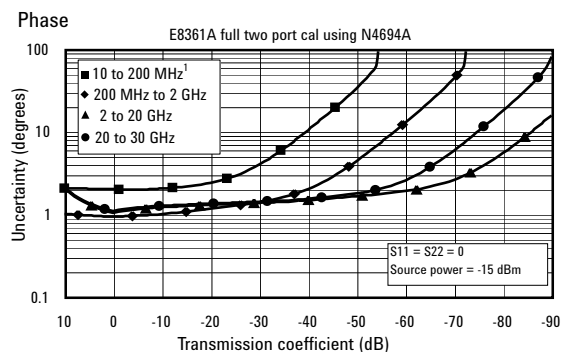
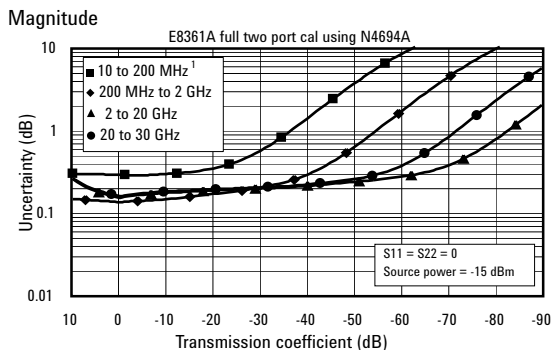

Reflection uncertainty (specifications)

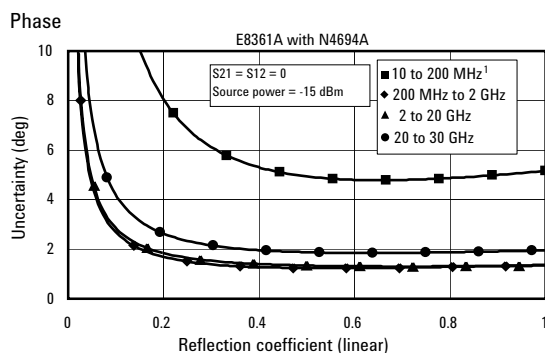
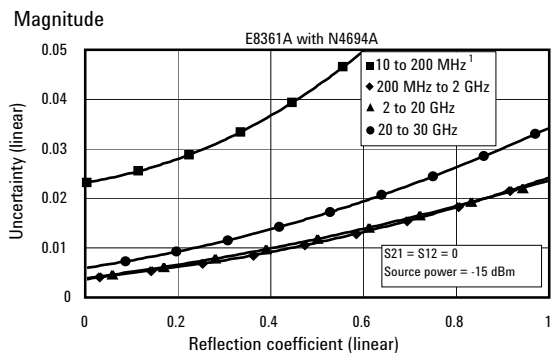

1. Typical performance.

E8361A

Corrected system performance with 1.85 mm connectors *continued*

Standard configuration and standard power range (E8361A)

Applies to E8361A PNA Series analyzer, N4694A
 (1.85 mm) ECal electronic calibration module, N4697E/F
 flexible test port cable set, and a full two-port calibration.
 (Specifications apply over environmental temperature
 of 23 °C ±3 °C, with less than 1 °C deviation from
 calibration temperature.)

Description	Specification (dB)			
	30 to 40 GHz	40 to 50 GHz	50 to 60 GHz	60 to 67 GHz
Directivity	44	42	41	38
Source match	34	33	30	27
Load match	33	32	29	26
Reflection tracking	±0.060 (+0.02/°C)	±0.070 (+0.02/°C)	±0.080 (+0.02/°C)	±0.090 (+0.03/°C)
Transmission tracking	±0.087 (+0.02/°C)	±0.102 (+0.02/°C)	±0.121 (+0.02/°C)	±0.147 (+0.03/°C)

Transmission uncertainty (specifications)

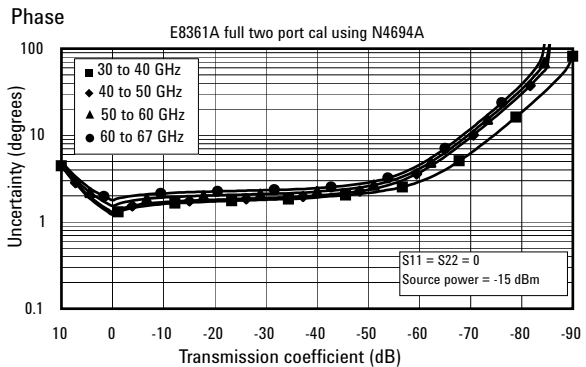
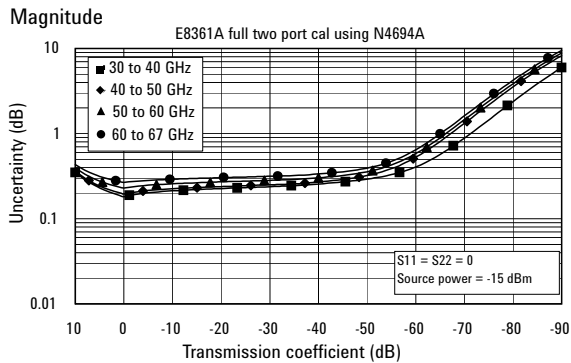

Reflection uncertainty (specifications)

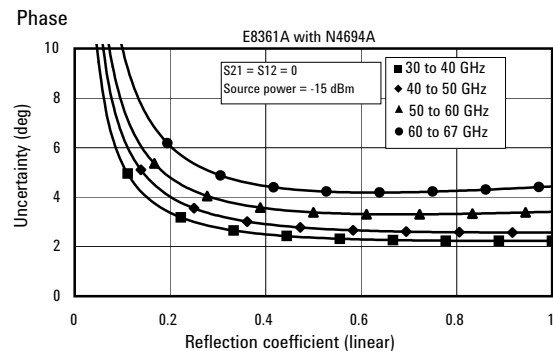
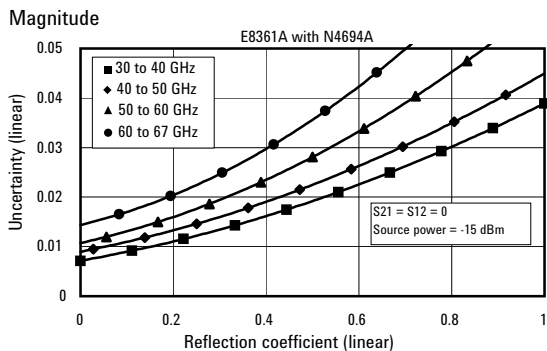

E8361A

Corrected system performance with 1.85 mm connectors *continued*

Fully optioned (E8361A with options 014/UNL/080/081/016)

Applies to E8361A PNA Series analyzer, N4694A (1.85 mm) ECal electronic calibration module, N4697F flexible test port cable set, and a full two-port calibration. (Specifications apply over environmental temperature of 23 °C ±3 °C, with less than 1 °C deviation from calibration temperature.)

Description	Specification (dB)			
	10 to 200 MHz ¹	200 MHz to 2 GHz	2 to 20 GHz	20 to 30 GHz
Directivity	33	33	50	46
Source match	25	25	39	35
Load match	25	25	37	34
Reflection tracking	±0.050 (+0.02/°C)	±0.050 (+0.02/°C)	±0.040 (+0.02/°C)	±0.050 (+0.02/°C)
Transmission tracking	±0.146 (+0.02/°C)	±0.146 (+0.02/°C)	±0.054 (+0.02/°C)	±0.068 (+0.02/°C)

Transmission uncertainty (specifications)

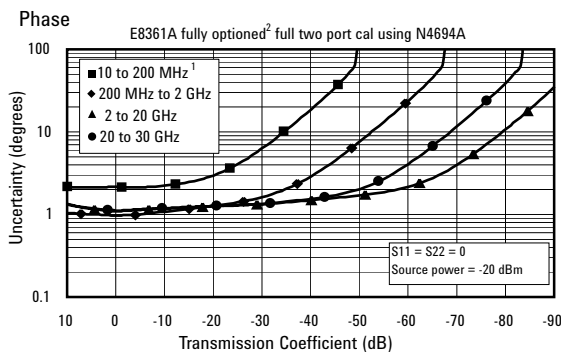
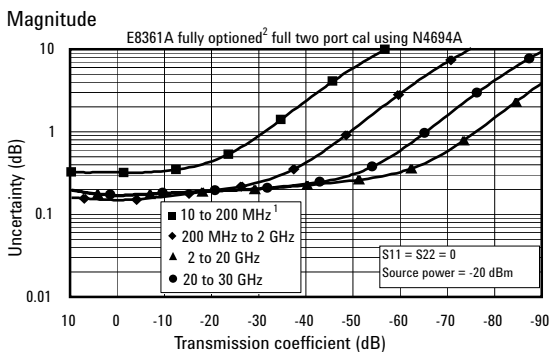

Reflection uncertainty (specifications)

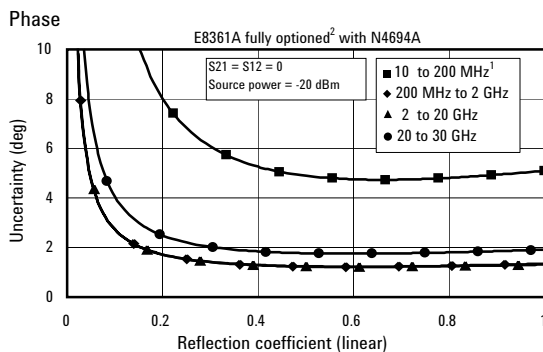
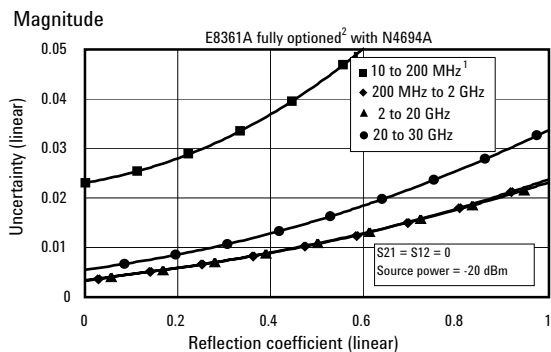

1. Typical performance.
 2. Configurable Test Set, Extended Power Range and Bias-Tees, Receiver Attenuators, Frequency Offset Mode, and Reference Channel Transfer Switch (Option 014, UNL, 016, 080 and 081).

E8361A

Corrected system performance with 1.85 mm connectors *continued*

Fully optioned (E8361A with options 014/UNL/080/081/016)

Applies to E8361A PNA Series analyzer, N4694A (1.85 mm) ECal electronic calibration module, 85133F flexible test port cable set, and a full two-port calibration. (Specifications apply over environmental temperature of 23 °C ±3 °C, with less than 1 °C deviation from calibration temperature.)

Description	Specification (dB)			
	30 to 40 GHz	40 to 50 GHz	50 to 60 GHz	60 to 67 GHz
Directivity	44	42	41	38
Source match	34	33	30	27
Load match	33	32	29	26
Reflection tracking	±0.060 (+0.02/°C)	±0.070 (+0.02/°C)	±0.080 (+0.02/°C)	±0.090 (+0.03/°C)
Transmission tracking	±0.082 (+0.02/°C)	±0.097 (+0.02/°C)	±0.112 (+0.02/°C)	±0.144 (+0.03/°C)

Transmission uncertainty (specifications)

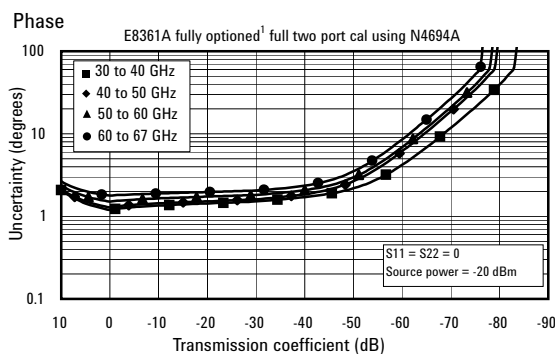
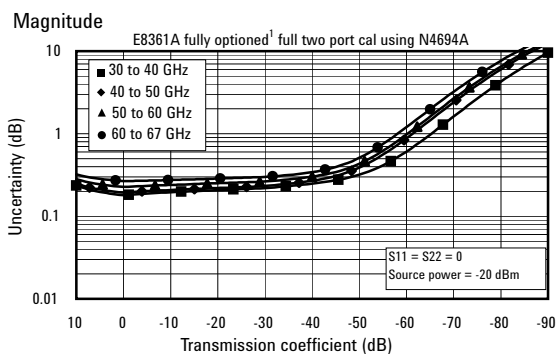

Reflection uncertainty (specifications)

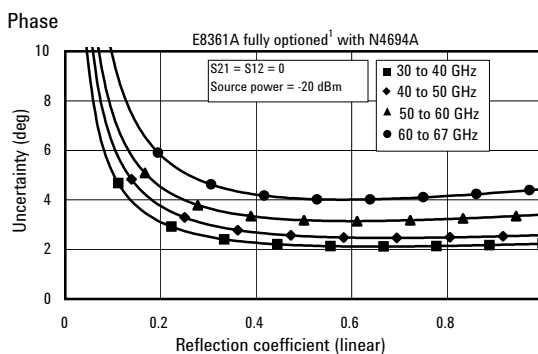
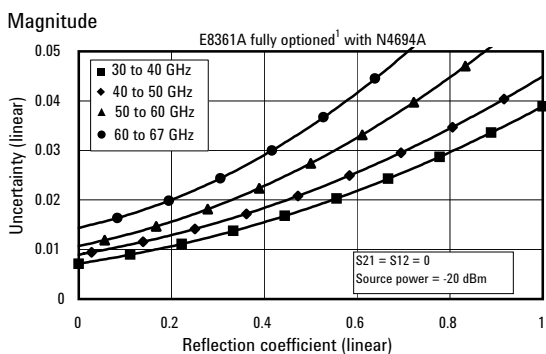

1. Configurable Test Set, Extended Power Range and Bias-Tees, Receiver Attenuators, Frequency Offset Mode, and Reference Channel Transfer Switch (Option 014, UNL, 016, 080 and 081).

E8361A

Corrected system performance with 1.85 mm connectors *continued*

Standard configuration and standard power range (E8361A)

Applies to E8361A PNA Series analyzer, 85058B (1.85 mm) calibration kit, N4697F flexible test port cable set, and a full two-port calibration. (Specifications apply over environmental temperature of 23 °C ±3 °C, with less than 1 °C deviation from calibration temperature.)

Description	Specification (dB)			
	10 to 45 MHz ¹	45 MHz to 2 GHz	2 to 10 GHz	10 to 20 GHz
Directivity	35	35	41	38
Source match	34	34	44	40
Load match	34	35	41	37
Reflection tracking	±0.019 (+0.02/°C)	±0.019 (+0.02/°C)	±0.010 (+0.02/°C)	±0.033 (+0.02/°C)
Transmission tracking	±0.164 (+0.02/°C)	±0.081 (+0.02/°C)	±0.036 (+0.02/°C)	±0.063 (+0.02/°C)

Transmission uncertainty (specifications)

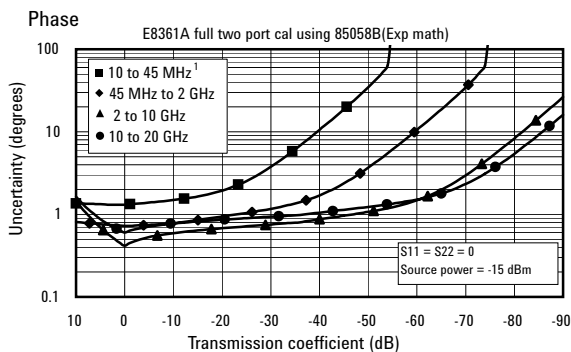
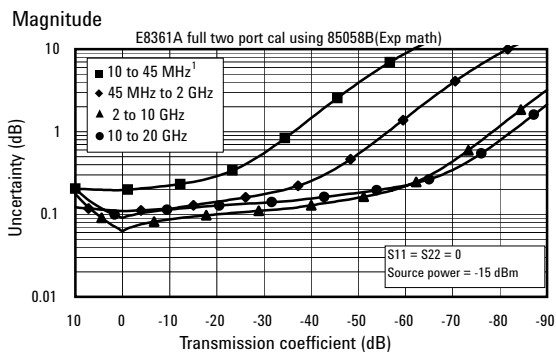

Reflection uncertainty (specifications)

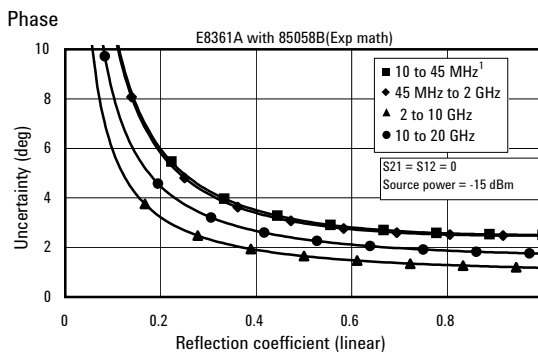
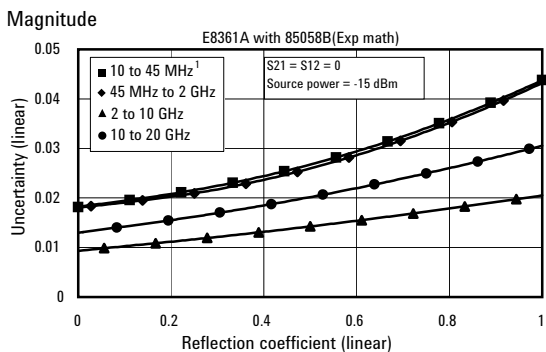

1. Typical performance.

E8361A

Corrected system performance with 1.85 mm connectors *continued*

Standard configuration and standard power range (E8361A)

Applies to E8361A PNA Series analyzer, 85058B (1.85 mm) calibration kit, N4697F flexible test port cable set, and a full two-port calibration. (Specifications apply over environmental temperature of 23 °C ±3 °C, with less than 1 °C deviation from calibration temperature.)

Description	Specification (dB)			
	20 to 35 GHz	35 to 50 GHz	50 to 60 GHz	60 to 67 GHz
Directivity	37	37	34	34
Source match	41	42	40	40
Load match	36	36	33	33
Reflection tracking	±0.033 (+0.02/°C)	±0.020 (+0.02/°C)	±0.030 (+0.02/°C)	±0.030 (+0.03/°C)
Transmission tracking	±0.097 (+0.02/°C)	±0.091 (+0.02/°C)	±0.140 (+0.02/°C)	±0.145 (+0.03/°C)

Transmission uncertainty (specifications)

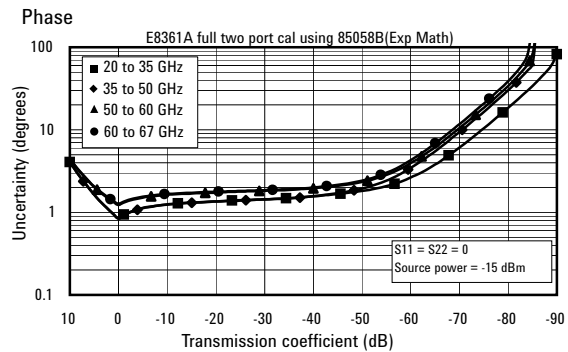
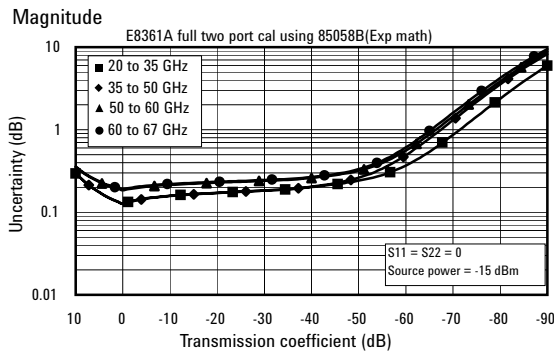

Reflection uncertainty (specifications)

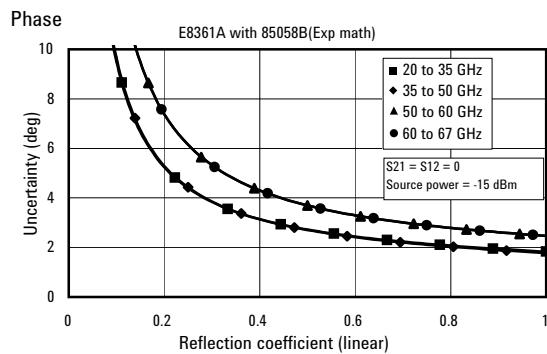
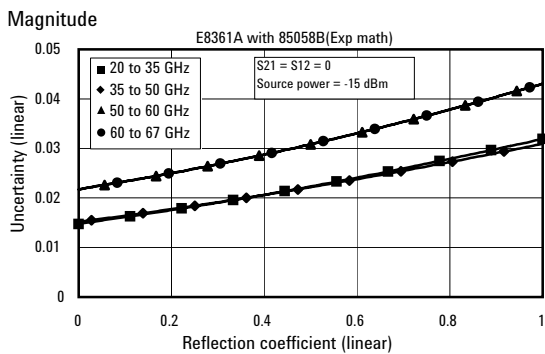

E8361A

Corrected system performance with 1.85 mm connectors *continued*

Fully optioned (E8361A with options 014/UNL/080/081/016)

Applies to E8361A PNA Series analyzer, 85058B (1.85 mm) calibration kit, N4697F flexible test port cable set, and a full two-port calibration. (Specifications apply over environmental temperature of 23 °C ±3 °C, with less than 1 °C deviation from calibration temperature.)

Description	Specification (dB)			
	10 to 45 MHz ¹	45 MHz to 2 GHz	2 to 10 GHz	10 to 20 GHz
Directivity	35	35	41	38
Source match	34	34	44	40
Load match	34	35	41	37
Reflection tracking	±0.019 (+0.02/°C)	±0.019 (+0.02/°C)	±0.010 (+0.02/°C)	±0.033 (+0.02/°C)
Transmission tracking	±0.177 (+0.02/°C)	±0.093 (+0.02/°C)	±0.053 (+0.02/°C)	±0.096 (+0.02/°C)

Transmission uncertainty (specifications)

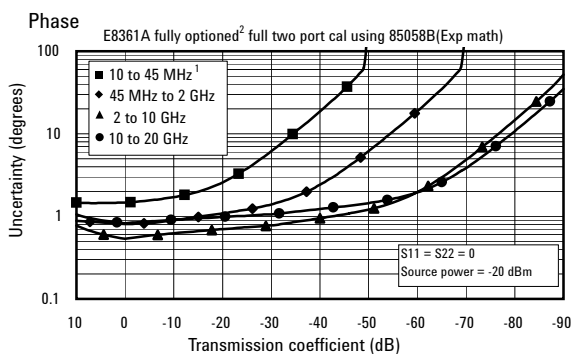
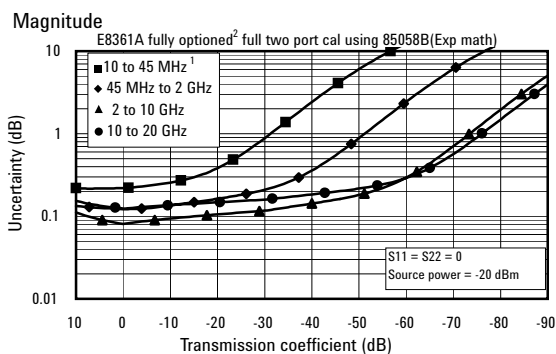

Reflection uncertainty (specifications)

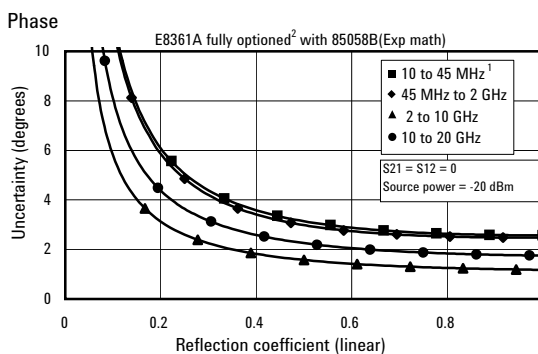
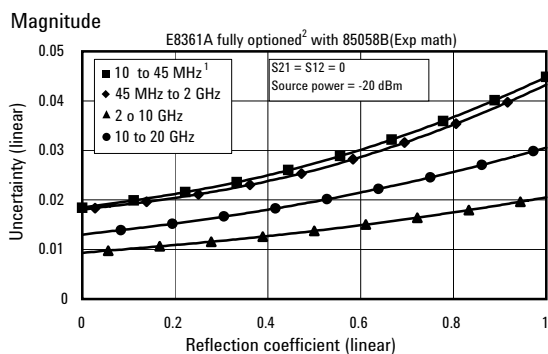

1. Typical performance.
2. Configurable Test Set, Extended Power Range and Bias-Tees, Receiver Attenuators, Frequency Offset Mode, and Reference Channel Transfer Switch (Option 014, UNL, 016, 080 and 081).

E8361A

Corrected system performance with 1.85 mm connectors *continued*

Fully optioned (E8361A with options 014/UNL/080/081/016)
 Applies to E8361A PNA Series analyzer, 85058B (1.85 mm) calibration kit, N4697F flexible test port cable set, and a full two-port calibration. (Specifications apply over environmental temperature of 23 °C ±3 °C, with less than 1 °C deviation from calibration temperature.)

Description	Specification (dB)			
	20 to 35 GHz	35 to 50 GHz	50 to 60 GHz	60 to 67 GHz
Directivity	37	37	34	34
Source match	41	42	40	40
Load match	36	36	33	33
Reflection tracking	±0.033 (+0.02/°C)	±0.020 (+0.02/°C)	±0.030 (+0.02/°C)	±0.030 (+0.03/°C)
Transmission tracking	±0.084 (+0.02/°C)	±0.079 (+0.02/°C)	±0.119 (+0.02/°C)	±0.137 (+0.03/°C)

Transmission uncertainty (specifications)

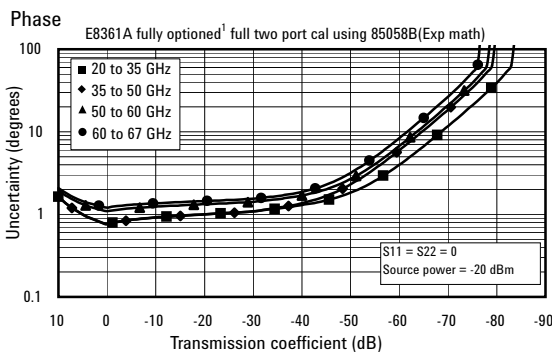
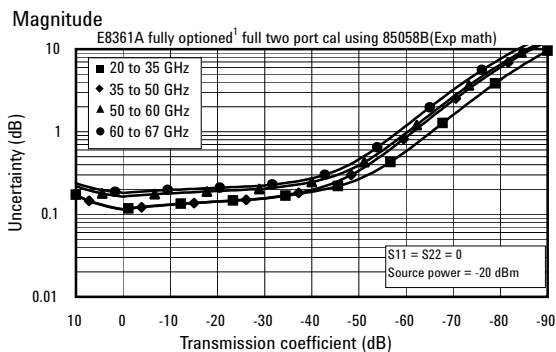

Reflection uncertainty (specifications)

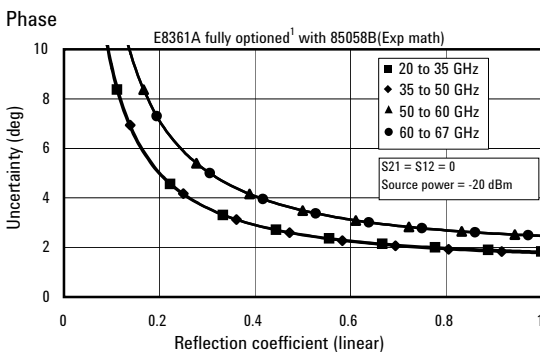
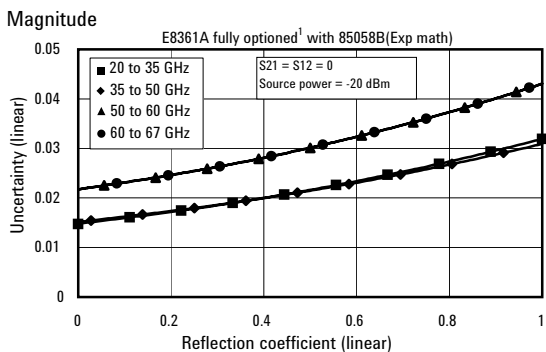

1. Configurable Test Set, Extended Power Range and Bias-Tees, Receiver Attenuators, Frequency Offset Mode, and Reference Channel Transfer Switch (Option 014, UNL, 016, 080 and 081).

E8361A

Corrected system performance with 2.4 mm connectors

Standard configuration and standard power range (E8361A)

Applies to E8361A PNA Series analyzer, N4693A (2.4 mm) ECal electronic calibration module, 85133F flexible test port cable set, and a full two-port calibration. (Specifications apply over environmental temperature of $23\text{ }^{\circ}\text{C} \pm 3\text{ }^{\circ}\text{C}$, with less than $1\text{ }^{\circ}\text{C}$ deviation from calibration temperature.)

Description	Specification (dB)				
	10 to 200 MHz ¹	200 MHz to 2 GHz	2 to 20 GHz	20 to 40 GHz	40 to 50 GHz
Directivity	32	55	49	43	41
Source match	25	46	42	35	30
Load match	24	43	41	37	36
Reflection tracking	$\pm 0.050 (+0.02/^{\circ}\text{C})$	$\pm 0.030 (+0.02/^{\circ}\text{C})$	$\pm 0.040 (+0.02/^{\circ}\text{C})$	$\pm 0.060 (+0.02/^{\circ}\text{C})$	$\pm 0.080 (+0.03/^{\circ}\text{C})$
Transmission tracking	$\pm 0.100 (+0.02/^{\circ}\text{C})$	$\pm 0.059 (+0.02/^{\circ}\text{C})$	$\pm 0.079 (+0.02/^{\circ}\text{C})$	$\pm 0.110 (+0.02/^{\circ}\text{C})$	$\pm 0.125 (+0.03/^{\circ}\text{C})$

Transmission uncertainty (specifications)

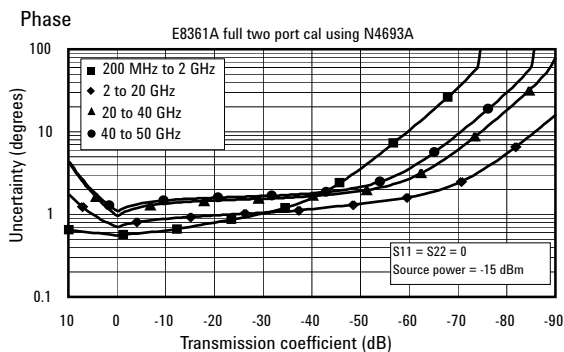
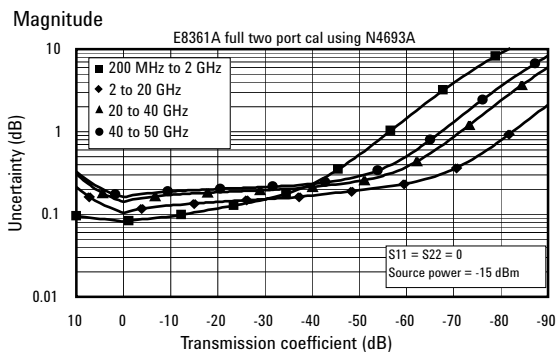

Reflection uncertainty (specifications)

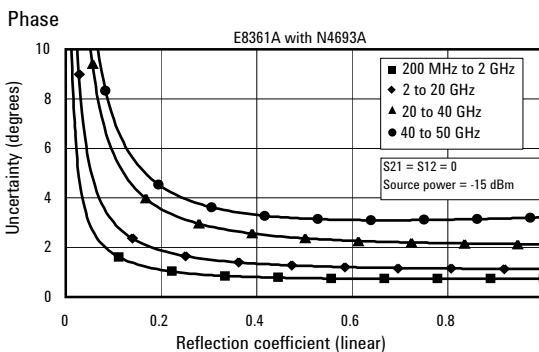
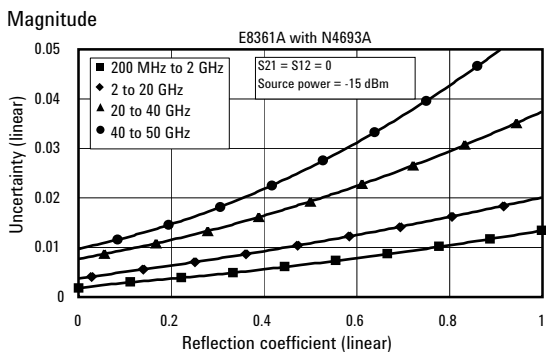

1. Typical performance.

E8361A

Corrected system performance with 2.4 mm connectors *continued*

Fully optioned (E8361A with options 014/UNL/080/081/016)

Applies to E8361A PNA Series analyzer, N4693A (2.4 mm) ECal electronic calibration module, 85133F flexible test port cable set, and a full two-port calibration. (Specifications apply over environmental temperature of 23 °C ±3 °C, with less than 1 °C deviation from calibration temperature.)

Description	Specification (dB)				
	10 to 200 MHz ¹	200 MHz to 2 GHz	2 to 20 GHz	20 to 40 GHz	40 to 50 GHz
Directivity	32	55	49	43	41
Source match	25	46	42	35	30
Load match	24	43	41	37	36
Reflection tracking	±0.050 (+0.02/°C)	±0.030 (+0.02/°C)	±0.040 (+0.02/°C)	±0.060 (+0.02/°C)	±0.080 (+0.03/°C)
Transmission tracking	±0.100 (+0.02/°C)	±0.060 (+0.02/°C)	±0.082 (+0.02/°C)	±0.106 (+0.02/°C)	±0.121 (+0.03/°C)

Transmission uncertainty (specifications)

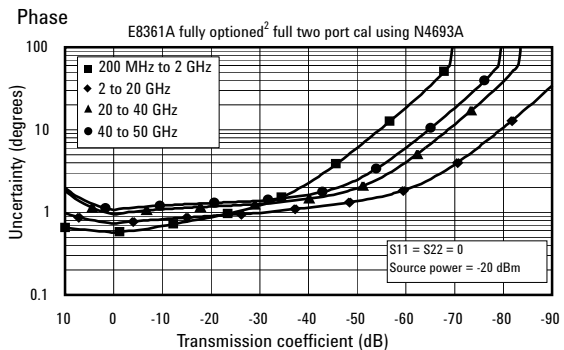
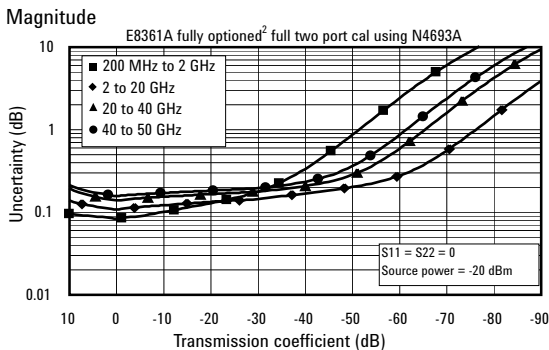

Reflection uncertainty (specifications)

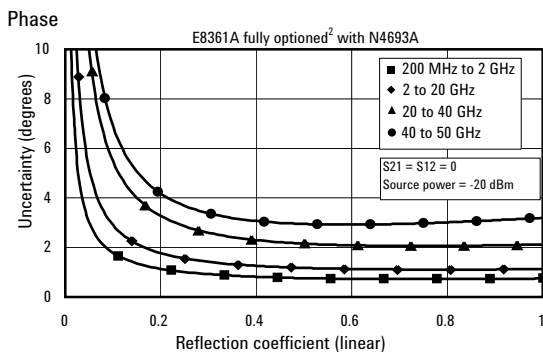
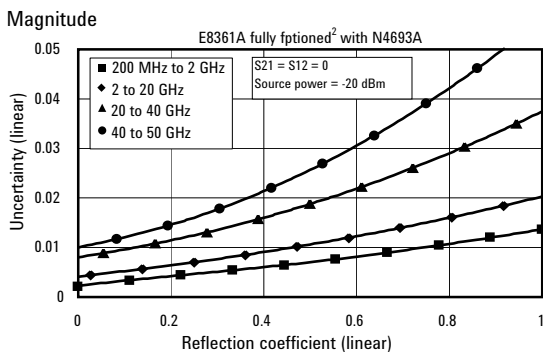

1. Typical performance.
2. Configurable Test Set, Extended Power Range and Bias-Tees, Receiver Attenuators, Frequency Offset Mode, and Reference Channel Transfer Switch (Option 014, UNL, 016, 080 and 081).

E8361A

Corrected system performance with 2.4 mm connectors *continued*

Standard configuration and standard power range (E8361A)

Applies to E8361A PNA Series analyzer, 85056A (2.4 mm) calibration kit, 85133F flexible test port cable set, and a full two-port calibration. (Specifications apply over environmental temperature of 23 °C ±3 °C, with less than 1 °C deviation from calibration temperature.)

Description	Specification (dB)			
	45 MHz to 2 GHz	2 to 20 GHz	20 to 40 GHz	40 to 50 GHz
Directivity	42	42	38	36
Source match	41	38	33	31
Load match	42	42	37	35
Reflection tracking	±0.001 (+0.02/°C)	±0.008 (+0.02/°C)	±0.020 (+0.02/°C)	±0.027 (+0.03/°C)
Transmission tracking	±0.035 (+0.02/°C)	±0.060 (+0.02/°C)	±0.146 (+0.02/°C)	±0.181 (+0.03/°C)

Transmission uncertainty (specifications)

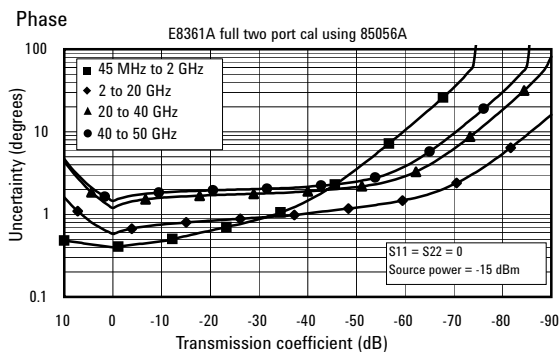
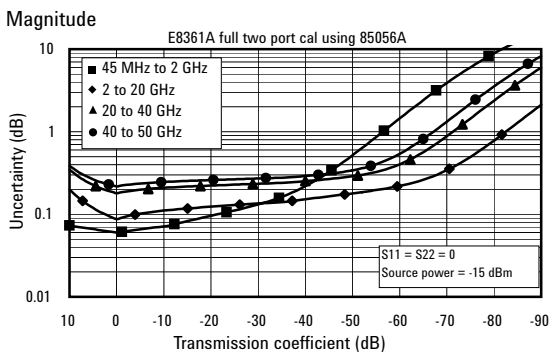

Reflection uncertainty (specifications)

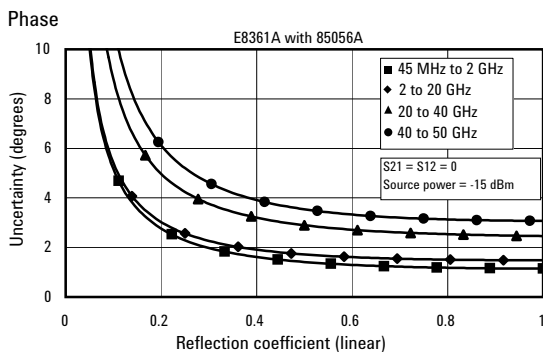
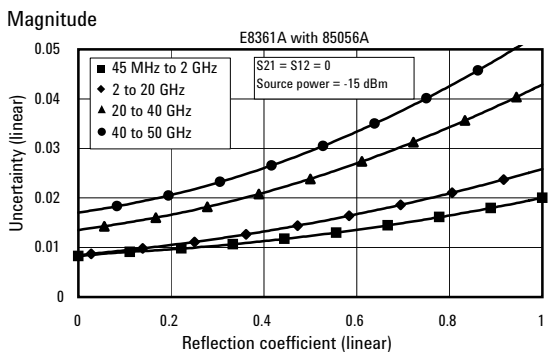

E8361A

Corrected system performance with 2.4 mm connectors *continued*

Fully optioned (E8361A with options 014/UNL/080/081/016)

Applies to E8361A PNA Series analyzer, 85056A (2.4 mm) calibration kit, 85133F flexible test port cable set, and a full two-port calibration. (Specifications apply over environmental temperature of 23 °C ±3 °C, with less than 1 °C deviation from calibration temperature.)

Description	Specification (dB)			
	45 MHz to 2 GHz	2 to 20 GHz	20 to 40 GHz	40 to 50 GHz
Directivity	42	42	38	36
Source match	41	38	33	31
Load match	42	41	37	35
Reflection tracking	±0.001 (+0.02/°C)	±0.008 (+0.02/°C)	±0.020 (+0.02/°C)	±0.027 (+0.03/°C)
Transmission tracking	±0.040 (+0.02/°C)	±0.086 (+0.02/°C)	±0.123 (+0.02/°C)	±0.155 (+0.03/°C)

Transmission uncertainty (specifications)

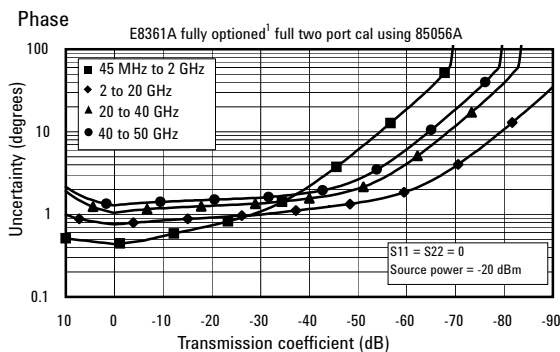
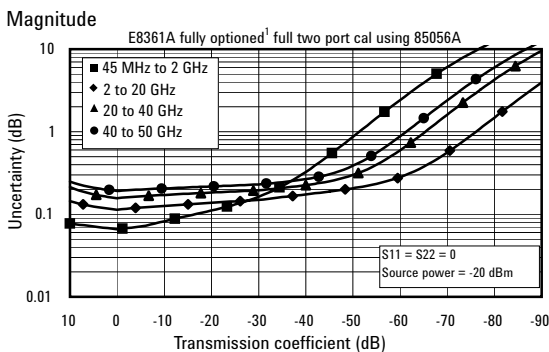

Reflection uncertainty (specifications)

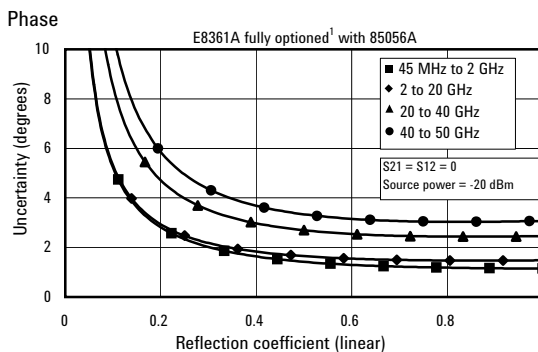
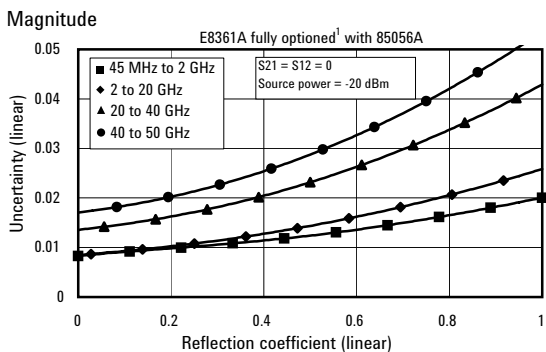

1. Configurable Test Set, Extended Power Range and Bias-Tees, Receiver Attenuators, Frequency Offset Mode, and Reference Channel Transfer Switch (Option 014, UNL, 016, 080 and 081).

E8361A

Uncorrected system performance ¹

Description	Specification	Typical
Directivity		
10 to 45 MHz ²	22 dB	22 dB
45 MHz to 2 GHz	24 dB	27 dB
2 to 10 GHz	20 dB	24 dB
10 to 20 GHz	16 dB	20 dB
20 to 30 GHz	14 dB	17 dB
30 to 50 GHz	13 dB	17 dB
50 to 60 GHz	13 dB	17 dB
60 to 67 GHz	10 dB	18 dB
67 to 70 GHz ²	14 dB	14 dB
Source match - standard		
10 to 45 MHz ²	7 dB	7 dB
45 MHz to 2 GHz	18 dB	23 dB
2 to 10 GHz	14 dB	18 dB
10 to 20 GHz	12 dB	15 dB
20 to 30 GHz	8 dB	11.5 dB
30 to 40 GHz	7.5 dB	10 dB
40 to 45 GHz	8 dB	11 dB
45 to 50 GHz	7 dB	10 dB
50 to 60 GHz	6 dB	8.5 dB
60 to 67 GHz	5.5 dB	7.5 dB
67 to 70 GHz ²	7.5 dB	7.5 dB
Source match - Option 014		
10 to 45 MHz ²	7 dB	7 dB
45 MHz to 2 GHz	17 dB	21 dB
2 to 10 GHz	12 dB	17 dB
10 to 20 GHz	11 dB	14 dB
20 to 30 GHz	10 dB	13 dB
30 to 40 GHz	8.5 dB	11 dB
40 to 45 GHz	8.5 dB	11 dB
45 to 50 GHz	8.5 dB	11.5 dB
50 to 60 GHz	6.5 dB	9 dB
60 to 67 GHz	6 dB	8.5 dB
67 to 70 GHz ²	8.5 dB	8.5 dB
Source match - Option 014 and UNL		
10 to 45 MHz ²	5 dB	5 dB
45 MHz to 2 GHz	15 dB	20 dB
2 to 10 GHz	9 dB	13 dB
10 to 20 GHz	7.5 dB	10.5 dB
20 to 30 GHz	8.5 dB	11 dB
30 to 40 GHz	8 dB	11 dB
40 to 45 GHz	8.5 dB	12 dB
45 to 50 GHz	8 dB	12 dB
50 to 60 GHz	7 dB	11 dB
60 to 67 GHz	6 dB	10 dB
67 to 70 GHz ²	10 dB	10 dB
Load match - standard		
10 to 45 MHz ²	5.5 dB	5.5 dB
45 MHz to 2 GHz	9 dB	10 dB
2 to 10 GHz	9 dB	11 dB
10 to 20 GHz	8.5 dB	10 dB
20 to 30 GHz	7 dB	9 dB
30 to 40 GHz	6 dB	8 dB
40 to 45 GHz	6.5 dB	9 dB
45 to 50 GHz	6.5 dB	8.5 dB
50 to 60 GHz	5.5 dB	7.5 dB
60 to 67 GHz	5.5 dB	7.5 dB
67 to 70 GHz ²	5 dB	5 dB

1. Specifications apply over environment temperature of 23 °C ± 3 °C, with less than 1 °C deviation from the calibration temperature.

2. Typical performance.

E8361A

Uncorrected system performance ¹ *continued*

Description	Specification	Typical
Load match - Option 014		
10 to 45 MHz ²	5.5 dB	5.5 dB
45 MHz to 2 GHz	8.5 dB	10 dB
2 to 10 GHz	8 dB	10 dB
10 to 20 GHz	8 dB	10 dB
20 to 30 GHz	7.5 dB	10 dB
30 to 40 GHz	7 dB	9.5 dB
40 to 45 GHz	7.5 dB	9.5 dB
45 to 50 GHz	7.5 dB	10 dB
50 to 60 GHz	6 dB	8.5 dB
60 to 67 GHz	6 dB	8.5 dB
67 to 70 GHz ²	5 dB	5 dB
Load match - Option 014 and UNL		
10 to 45 MHz ²	6 dB	6 dB
45 MHz to 2 GHz	8.5 dB	10 dB
2 to 10 GHz	7 dB	9 dB
10 to 20 GHz	6 dB	9 dB
20 to 30 GHz	7.5 dB	11 dB
30 to 40 GHz	8 dB	11.5 dB
40 to 45 GHz	8 dB	12 dB
45 to 50 GHz	8 dB	12 dB
50 to 60 GHz	7.5 dB	11.5 dB
60 to 67 GHz	6 dB	10 dB
67 to 70 GHz ²	13 dB	13 dB

1. Specifications apply over environment temperature of 23 °C ± 3 °C, with less than 1 °C deviation from the calibration temperature.

2. Typical performance.

E8361A

Uncorrected system performance ¹ *continued*

Description	Specification	Supplemental information
Reflection tracking		Typical:
10 to 45 MHz		±1.5 dB
45 MHz to 20 GHz		±1.5 dB
20 to 40 GHz		±2.0 dB
40 to 50 GHz		±2.0 dB
50 to 67 GHz		±3.0 dB
67 to 70 GHz		±4.5 dB
Transmission tracking ³		Typical:
10 to 45 MHz		±1.5 dB
45 MHz to 20 GHz		±1.5 dB
20 to 40 GHz		±2.0 dB
40 to 50 GHz		±2.0 dB
50 to 67 GHz		±3.0 dB
67 to 70 GHz		±4.5 dB
Crosstalk ⁴ - standard		
10 to 45 MHz ²	63 dB	
45 to 500 MHz	87 dB	
500 MHz to 2 GHz	110 dB	
2 to 10 GHz	105 dB	
10 to 24 GHz	111 dB	
24 to 30 GHz	106 dB	
30 to 40 GHz	104 dB	
40 to 45 GHz	98 dB	
45 to 50 GHz	100 dB	
50 to 60 GHz	97 dB	
60 to 67 GHz	94 dB	
67 to 70 GHz ²	94 dB	
Crosstalk ⁴ - Option 014		Typical (for Option 080 enabled ⁵)
10 to 45 MHz ²	63 dB	63 dB
45 to 500 MHz	87 dB	87 dB
500 MHz to 2 GHz	110 dB	110 dB
2 to 10 GHz	105 dB	105 dB
10 to 24 GHz	111 dB	111 dB
24 to 30 GHz	104 dB	104 dB
30 to 40 GHz	102 dB	102 dB
40 to 45 GHz	96 dB	96 dB
45 to 50 GHz	98 dB	98 dB
50 to 60 GHz	95 dB	95 dB
60 to 67 GHz	90 dB	90 dB
67 to 70 GHz ²	90 dB	90 dB
Crosstalk - Option 014 and UNL		Typical (for Option UNL and Option 014 with 080 enabled ⁵)
10 to 45 MHz ²	63 dB	63 dB
45 to 500 MHz	87 dB	87 dB
500 MHz to 2 GHz	110 dB	110 dB
2 to 10 GHz	104 dB	104 dB
10 to 24 GHz	108 dB	108 dB
24 to 30 GHz	101 dB	101 dB
30 to 40 GHz	99 dB	99 dB
40 to 45 GHz	92 dB	92 dB
45 to 50 GHz	94 dB	94 dB
50 to 60 GHz	91 dB	91 dB
60 to 67 GHz	84 dB	84 dB
67 to 70 GHz ²	84 dB	84 dB

1. Specifications apply over environment temperature of 23 °C ± 3 °C, with less than 1 °C deviation from the calibration temperature.
 2. Typical performance.
 3. Transmission tracking performance noted here is normalized to the insertion loss characteristics of the cable used, so that the indicated performance is independent of cable used.

4. Measurement conditions: Normalized to a thru, measured with two shorts, 10-Hz IF bandwidth, averaging factor of 16, alternate mode, source power set to the lesser of the maximum power out or the maximum receiver power.
 5. 0 Hz offset.

E8361A

Test port output

Description	Specification Standard	Option 014	Option UNL and Option 014	Supplemental information
Frequency range E8361A		10 MHz to 67 GHz (Operation up to 70 GHz)		
Nominal power ¹	-15 dBm	-15 dBm	-17 dBm	
Frequency resolution	1 Hz	1 Hz	1 Hz	
CW accuracy	± 1ppm	± 1ppm	± 1ppm	
Frequency stability				± 0.05 ppm -10 to 70 °C, typical ±0.1 ppm/yr maximum, typical
Power level accuracy ²				
10 to 45 MHz ³	±1.5 dB	±1.5 dB	±1.5 dB	Variation from nominal power in range 0
45 MHz to 10 GHz	±1.5 dB	±1.5 dB	±1.5 dB	
10 to 20 GHz	±1.5 dB	±1.5 dB	±2.0 dB	
20 to 30 GHz	±2.0 dB	±2.0 dB	±2.5 dB	
30 to 40 GHz	±3.0 dB	±3.0 dB	±3.0 dB	
40 to 45 GHz	±3.0 dB	±3.0 dB	±3.0 dB	
45 to 50 GHz	±3.5 dB	±3.5 dB	±3.5 dB	
50 to 60 GHz	±4.0 dB	±4.0 dB	±4.0 dB	
60 to 67 GHz	±4.0 dB	±4.0 dB	±4.5 dB	
67 to 70 GHz ³	±4.0 dB	±4.0 dB	±4.5 dB	
Power level linearity ⁴				
10 to 45 MHz ³	±1.0 dB ⁵	±1.0 dB ⁵	±1.0 dB ⁵	For power ≤ -5 dBm Test reference is at the nominal power level (step attenuator at 0 dB)
45 MHz to 67 GHz	±1.0 dB ⁵	±1.0 dB ⁵	±1.0 dB ⁵	
67 to 70 GHz ³	±1.0 dB ⁵	±1.0 dB ⁵	±1.0 dB ⁵	
Power range ^{2, 6, 7}				
Note: If the power is set above maximum specified leveled power, the test port output signal may show non-linear effects that are dependent on the DUT.				
10 to 45 MHz ³	-25 to -9 dBm	-25 to -9 dBm	-75 to -9 dBm	
45 to 500 MHz	-25 to -3 dBm	-25 to -3 dBm	-75 to -3 dBm	
500 to 750 MHz	-25 to 0 dBm	-25 to 0 dBm	-75 to 0 dBm	
750 MHz to 10 GHz	-27 to -1 dBm	-27 to -1 dBm	-77 to -1 dBm	
10 to 30 GHz	-27 to -2 dBm	-27 to -3 dBm	-77 to -3 dBm	
30 to 40 GHz	-27 to -1 dBm	-27 to -2 dBm	-77 to -5 dBm	
40 to 45 GHz	-27 to -7 dBm	-27 to -8 dBm	-77 to -10 dBm	
45 to 50 GHz	-27 to -1 dBm	-27 to -2 dBm	-77 to -6 dBm	
50 to 60 GHz	-27 to -3 dBm	-27 to -4 dBm	-77 to -8 dBm	
60 to 67 GHz	-27 to -5 dBm	-27 to -7 dBm	-77 to -13 dBm	
67 to 70 GHz ³	-27 to -5 dBm	-27 to -7 dBm	-77 to -13 dBm	
Power sweep range (ALC)				
10 to 45 MHz ³	16 dB	16 dB	16 dB	ALC range starts at maximum leveled output power and decreases by the dB amount specified
45 to 500 MHz	22 dB	22 dB	22 dB	
500 to 750 MHz	25 dB	25 dB	25 dB	
750 MHz to 10 GHz	26 dB	26 dB	26 dB	
10 to 30 GHz	25 dB	24 dB	24 dB	
30 to 40 GHz	26 dB	25 dB	22 dB	
40 to 45 GHz	20 dB	19 dB	17 dB	
45 to 50 GHz	26 dB	25 dB	21 dB	
50 to 60 GHz	24 dB	23 dB	19 dB	
60 to 67 GHz	22 dB	20 dB	14 dB	
67 to 70 GHz ³	22 dB	20 dB	14 dB	
Power resolution	0.01 dB	0.01 dB		

1. Preset power.

2. Test port output is a specification when the source is set to port 1, and a characteristic when the source is set to port 2.

3. Typical performance.

4. Power level linearity is a specification when the source is set to port 1, and a typical when the source is set to port 2.

5. ±1.6 dB for power > -5 dBm.

6. Power to which the source can be set and phase lock is assured.

7. Test port is specified into a nominal 50 Ω.

E8361A

Test port output *continued*

Description	Specification	Supplemental information
Phase noise (10 kHz offset from center frequency, nominal power at test port)		
10 to 45 MHz		80 dBc typical
45 MHz to 10 GHz		70 dBc typical
10 to 24 GHz		60 dBc typical
24 to 70 GHz		55 dBc typical
Phase noise (10 kHz from center frequency, nominal power at test port) – Option 080 enabled		
10 to 45 MHz		80 dBc, typical
45 MHz to 10 GHz		70 dBc, typical
10 to 24 GHz		60 dBc, typical
24 to 70 GHz		55 dBc, typical
Phase noise (100 kHz from center frequency, nominal power at test port)		
10 to 45 MHz		90 dBc, typical
45 MHz to 10 GHz		90 dBc, typical
10 to 24 GHz		85 dBc, typical
24 to 70 GHz		75 dBc, typical
Phase noise (100 kHz from center frequency, nominal power at test port) – Option 080 enabled		
10 to 45 MHz		85 dBc, typical
45 MHz to 10 GHz		80 dBc, typical
10 to 24 GHz		70 dBc, typical
24 to 70 GHz		60 dBc, typical
Phase noise (1 MHz from center frequency, nominal power at test port)		
10 to 45 MHz		115 dBc, typical
45 MHz to 10 GHz		110 dBc, typical
10 to 24 GHz		105 dBc, typical
24 to 70 GHz		95 dBc, typical
Phase noise (1 MHz from center frequency, nominal power at test port) – Option 080 enabled		
10 to 45 MHz		110 dBc, typical
45 MHz to 10 GHz		105 dBc, typical
10 to 24 GHz		95 dBc, typical
24 to 70 GHz		85 dBc, typical
Harmonics (2nd or 3rd)		
10 to 500 MHz		10 dBc typical, in power
500 MHz to 10 GHz		15 dBc typical, in power
10 to 24 GHz		23 dBc typical, in power
24 to 50 GHz		16 dBc typical, in power
50 to 60 GHz		13 dBc typical, in power
60 to 70 GHz		19 dBc typical, in power
Non-harmonic spurious (at nominal output power)		
10 MHz to 20 GHz		-50 dBc typical, for offset frequency > 1 kHz
20 MHz to 70 GHz		-30 dBc typical, for offset frequency > 1 kHz

E8361A

Test port input

Description	Specification Standard	Option 014 or Option UNL and 014	Option 016	Supplemental information
Test port noise floor ¹				080 enabled,⁵ typical
10 Hz IF bandwidth				
10 to 45 MHz ³	< -70 dBm	< -70 dBm	< -70 dBm	< -70 dBm
45 to 500 MHz ^{2, 4}	< -90 dBm	< -90 dBm	< -90 dBm	< -90 dBm
500 MHz to 2 GHz	< -112 dBm	< -112 dBm	< -112 dBm	< -112 dBm
2 to 10 GHz	< -112 dBm	< -112 dBm	< -112 dBm	< -112 dBm
10 to 24 GHz	< -116 dBm	< -115 dBm	< -115 dBm	< -115 dBm
24 to 30 GHz	< -105 dBm	< -104 dBm	< -102 dBm	< -104 dBm
30 to 40 GHz	< -105 dBm	< -104 dBm	< -102 dBm	< -104 dBm
40 to 45 GHz	< -103 dBm	< -102 dBm	< -100 dBm	< -102 dBm
45 to 50 GHz	< -101 dBm	< -100 dBm	< -98 dBm	< -100 dBm
50 to 60 GHz	< -100 dBm	< -99 dBm	< -97 dBm	< -99 dBm
60 to 67 GHz	< -99 dBm	< -97 dBm	< -94 dBm	< -97 dBm
67 to 70 GHz ³	< -99 dBm	< -97 dBm	< -94 dBm	< -97 dBm
<div style="display: flex; justify-content: space-between; align-items: center;"> <div style="width: 60%;"></div> <div style="width: 30%; text-align: right;"> } Option 016 degrades performance by 2 dB. } Option 016 degrades performance by 3 dB. </div> </div>				
1 kHz IF bandwidth				
10 to 45 MHz ³	< -50 dBm	< -50 dBm	< -50 dBm	< -50 dBm
45 to 500 MHz ^{2, 4}	< -70 dBm	< -70 dBm	< -70 dBm	< -70 dBm
500 MHz to 2 GHz	< -92 dBm	< -92 dBm	< -92 dBm	< -92 dBm
2 to 10 GHz	< -92 dBm	< -92 dBm	< -92 dBm	< -92 dBm
10 to 24 GHz	< -96 dBm	< -95 dBm	< -95 dBm	< -95 dBm
24 to 30 GHz	< -85 dBm	< -84 dBm	< -82 dBm	< -84 dBm
30 to 40 GHz	< -85 dBm	< -84 dBm	< -82 dBm	< -84 dBm
40 to 45 GHz	< -83 dBm	< -82 dBm	< -80 dBm	< -82 dBm
45 to 50 GHz	< -81 dBm	< -80 dBm	< -78 dBm	< -80 dBm
50 to 60 GHz	< -80 dBm	< -79 dBm	< -77 dBm	< -79 dBm
60 to 67 GHz	< -79 dBm	< -77 dBm	< -74 dBm	< -77 dBm
67 to 70 GHz ³	< -79 dBm	< -77 dBm	< -74 dBm	< -77 dBm
<div style="display: flex; justify-content: space-between; align-items: center;"> <div style="width: 60%;"></div> <div style="width: 30%; text-align: right;"> } Option 016 degrades performance by 2 dB. } Option 016 degrades performance by 3 dB. </div> </div>				

1. Total average (rms) noise power calculated as mean value of a linear magnitude trace expressed in dBm.
2. Noise floor may be degraded by 10 dB at particular frequencies (multiples of 5 MHz) due to spurious receiver residuals.
3. Typical performance.
4. Specified value is for worst-case noise floor at 45 MHz.
5. 0 Hz offset.

E8361A

Test port input *continued*

Description	Specification Standard	Option 014 or Option 014 and UNL (typ.)	Supplemental information
Direct receiver access input noise floor¹			
10 Hz IF bandwidth			
10 to 45 MHz ²		< -106 dBm	Online Help also includes the
45 to 500 MHz ^{4, 5}		< -105 dBm	
500 MHz to 2 GHz		< -125.5 dBm	category "Direct receiver access
2 to 10 GHz		< -125 dBm	input noise floor, Option 080 enabled"
10 to 24 GHz		< -128 dBm	
24 to 30 GHz		< -117.5 dBm	} Option 016 degrades performance by 2 dB.
30 to 40 GHz		< -117 dBm	
40 to 45 GHz		< -115 dBm	
45 to 50 GHz		< -112.5 dBm	} Option 016 degrades performance by 3 dB.
50 to 60 GHz		< -111 dBm	
60 to 67 GHz		< -108 dBm	
67 to 70 GHz ²		< -107 dBm	
1 kHz IF bandwidth			
10 to 45 MHz ²		< -86 dBm	
45 to 500 MHz ^{4, 5}		< -85 dBm	
500 MHz to 2 GHz		< -105.5 dBm	
2 to 10 GHz		< -105 dBm	
10 to 24 GHz		< -108 dBm	} Option 016 degrades performance by 2 dB.
24 to 30 GHz		< -97.5 dBm	
30 to 40 GHz		< -97 dBm	
40 to 45 GHz		< -95 dBm	} Option 016 degrades performance by 3 dB.
45 to 50 GHz		< -92.5 dBm	
50 to 60 GHz		< -91 dBm	
60 to 67 GHz		< -88 dBm	
67 to 70 GHz ²		< -87 dBm	

Description	Specification			Supplemental
	Standard	Option 014	Option 014 and UNL	Information
Receiver compression level (measured at Test Ports)				
	Specifications			Typical
10 to 45 MHz ^{2, 3}	negligible	negligible	negligible	negligible
45 to 500 MHz ^{3, 6}	<0.1 dB at -9.5 dBm ⁷	<0.1 dB at -9.5 dBm ⁷	<0.1 dB at -9.5 dBm ⁷	<0.1 dB at +0.5 dBm ⁷
	and <0.25 dB at -3 dBm	and <0.25 dB at -3 dBm	and <0.25 dB at -3 dBm	and <0.25 dB at +8 dBm
500 MHz to 5 GHz	<0.1 dB at -8 dBm ⁷	<0.1 dB at -8 dBm ⁷	<0.1 dB at -7 dBm ⁷	<0.1 dB at -4 dBm ⁷
	and <0.25 dB at -1 dBm	and <0.25 dB at -1 dBm	and <0.25 dB at 0 dBm	and <0.25 dB at +3 dBm
5 to 30 GHz	<0.1 dB at -8.5 dBm ⁷	<0.1 dB at -8.5 dBm ⁷	<0.1 dB at -6 dBm ⁷	<0.1 dB at -1 dBm ⁷
	and <0.25 dB at -2 dBm	and <0.25 dB at -2 dBm	and <0.25 dB at +1 dBm	and <0.25 dB at +6 dBm
30 to 67 GHz	< 0.1 dB at -10.5 dBm ⁷	< 0.1 dB at -8 dBm ⁷	<0.1 dB at -9.5 dBm ⁷	<0.1 dB at -2 dBm ^{7, 8}
	and <0.15 dB at -7 dBm	and <0.15 dB at -4 dBm	and <0.15 dB at -6 dBm	and <0.15 dB at +2 dBm ⁸
67 to 70 GHz ²				<0.1 dB at -2 dBm ^{7, 8}
				and <0.15 dB at +2 dBm ⁸

1. Total average (rms) noise power calculated as mean value of a linear magnitude trace expressed in dBm.
 2. Typical performance.
 3. Coupler roll-off will reduce compression to a negligible level below 500 MHz.
 4. Noise floor may be degraded by 10 dB at particular frequencies (multiples of 5 MHz) due to spurious receiver residuals.

5. Specified value is for worst-case noise floor at 45 MHz.
 6. Specified value is for worst-case compression at 500 MHz.
 7. This compression level comes from the dynamic accuracy curve with -30 dBm reference test port power.
 8. Option 016 degrades performance by 3 dB.

E8361A

Test port input *continued*

Description	Specification Standard or Option 014	Option UNL and Option 014	Supplemental information
Third Order Intercept¹ – Tone spacing from 100 kHz to 5 MHz			
10 to 500 MHz			Typical: +30 dBm
500 MHz to 24 GHz			+24 dBm
24 to 40 GHz			+23 dBm
40 to 50 GHz			+24 dBm
50 to 67 GHz			+26 dBm
Third Order Intercept¹ – Tone spacing from 5 to 20 MHz			
10 to 500 MHz			Typical: Not applicable
500 MHz to 24 GHz			+20 dBm
24 to 40 GHz			+20 dBm
40 to 50 GHz			+22 dBm
50 to 67 GHz			+24 dBm
Third Order Intercept¹ – Tone spacing from 20 to 50 MHz			
10 to 500 MHz			Typical: Not applicable
500 MHz to 24 GHz			+26 dBm
24 to 40 GHz			+24 dBm
40 to 50 GHz			+25 dBm
50 to 67 GHz			+27 dBm
System compression level – at maximum leveled output power			
See Dynamic Accuracy Chart			
Trace noise magnitude			
10 to 45 MHz ²	< 0.150 dB rms	< 0.150 dB rms	1 kHz IF bandwidth ratio measurement, nominal power at test port
45 to 500 MHz ^{4, 5}	< 0.010 dB rms	< 0.010 dB rms	
500 MHz to 24 GHz	< 0.006 dB rms	< 0.006 dB rms	
24 to 67 GHz	< 0.006 dB rms	< 0.009 dB rms	
67 to 70 GHz ²	< 0.006 dB rms	< 0.009 dB rms	
Trace noise magnitude² – Option 080 enabled³			
10 to 45 MHz	< 0.150 dB rms	< 0.150 dB rms	1 kHz IF bandwidth ratio measurement, nominal power at test port
45 to 500 MHz ^{4, 5}	< 0.010 dB rms	< 0.010 dB rms	
500 MHz to 24 GHz	< 0.006 dB rms	< 0.006 dB rms	
24 to 67 GHz	< 0.009 dB rms	< 0.012 dB rms	
67 to 70 GHz	< 0.009 dB rms	< 0.012 dB rms	
Trace noise phase			
10 to 45 MHz ²	< 0.800° rms	< 0.800° rms	1 kHz IF bandwidth ratio measurement, nominal power at test port
45 to 500 MHz ⁵	< 0.100° rms	< 0.100° rms	
500 MHz to 24 GHz	< 0.060° rms	< 0.060° rms	
24 to 67 GHz	< 0.100° rms	< 0.100° rms	
67 to 70 GHz ²	< 0.100° rms	< 0.100° rms	
Trace noise phase² – Option 080 enabled³			
10 to 45 MHz	< 0.800° rms	< 0.800° rms	1 kHz IF bandwidth ratio measurement, nominal power at test port
45 to 500 MHz ⁵	< 0.100° rms	< 0.100° rms	
500 MHz to 24 GHz	< 0.060° rms	< 0.060° rms	
24 to 67 GHz	< 0.100° rms	< 0.100° rms	
67 to 70 GHz	< 0.100° rms	< 0.100° rms	

1. Third order intercept is a typical specification that applies while the network analyzer receiver is in its linear range.

2. Typical performance.

3. 0 Hz offset.

4. Trace noise magnitude may be degraded to 20 dB rms at harmonic frequencies of the first IF (8.33 MHz) below 80 MHz.

5. Specified value is for worst-case noise floor at 45 MHz.

E8361A

Test port input *continued*

Description	Specification Standard	Option 014	Supplemental information
Reference level magnitude			
Range	±500 dB	±500 dB	
Resolution	0.001 dB	0.001 dB	
Reference level phase			
Range	±500°	±500°	
Resolution	0.01°	0.01°	
Stability magnitude ¹			
10 to 45 MHz			Typical ratio measurement: Measured at the test port
45 MHz to 20 GHz			
20 to 40 GHz			
40 to 50 GHz			
50 to 70 GHz			
Stability phase ¹			
10 to 45 MHz			Typical ratio measurement: Measured at the test port
45 MHz to 20 GHz			
20 to 40 GHz			
40 to 50 GHz			
50 to 70 GHz			
Damage input level			
Test port 1 and 2			+27 dBm or ±40 VDC, typical
R1, R2 in			
A, B in			
Coupler thru (Option 014)			+27 dBm or ±40 VDC, typical
Coupler arm (Option 014)			+30 dBm or ±7 VDC, typical
Source out (reference)			+15 dBm or ±15 VDC, typical
Source out (test ports)			+27 dBm or ±5 VDC, typical

1. Stability is defined as a ratio measurement measured at the test port.

E8361A

Test port input *continued*

Group delay ¹

Description	Specification	Supplemental information (typical)
Aperture (selectable)		(frequency span)/(number of points – 1)
Maximum aperture		20% of frequency span
Range		0.5 x (1/minimum aperture)
Maximum delay		Limited to measuring no more than 180° of phase change within the minimum aperture.

The following graph shows characteristic group delay accuracy with type-N full 2-port calibration and a 10 Hz IF bandwidth. Insertion loss is assumed to be less than 2 dB and electrical length to be 10 m.

Group delay (typical)

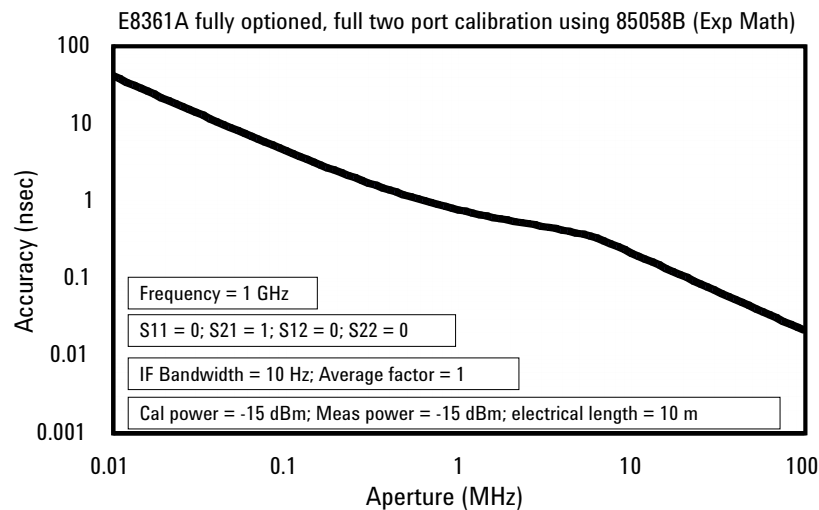

In general, the following formula can be used to determine the accuracy, in seconds, of a specific group delay measurement:

$$\pm \text{Phase accuracy (deg)} / [360 \times \text{Aperture (Hz)}]$$

Depending on the aperture and device length, the phase accuracy used is either incremental phase accuracy or worse case phase accuracy.

1. Group delay is computed by measuring the phase change within a specified frequency step (determined by the frequency span and the number of points per sweep).

E8361A

Test port input *continued*

Dynamic accuracy (specification)¹

Applies to input ports 1 and 2, accuracy of the test port input power reading relative to the reference input power level. Also applies to the following conditions:

- IF bandwidth = 10 Hz

Note: If the power is set above maximum specified leveled power, the test port output signal may show non-linear effects that are dependent on the DUT.

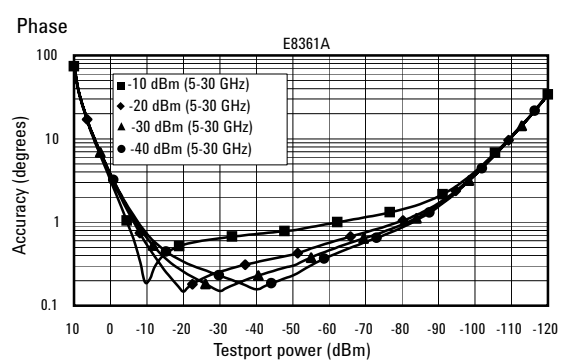
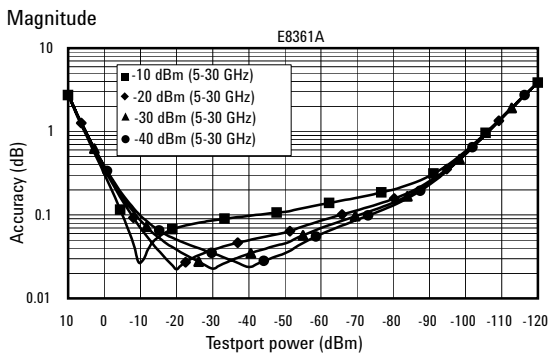
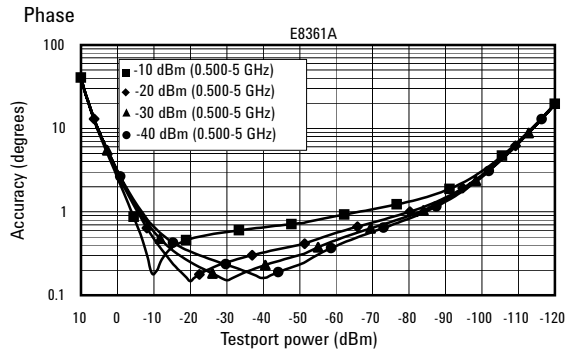
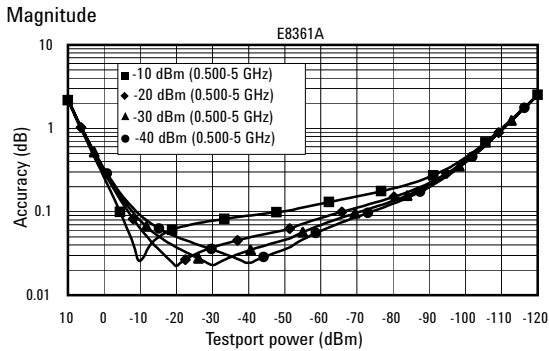
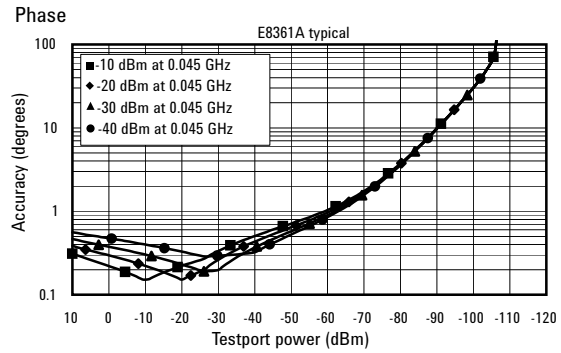
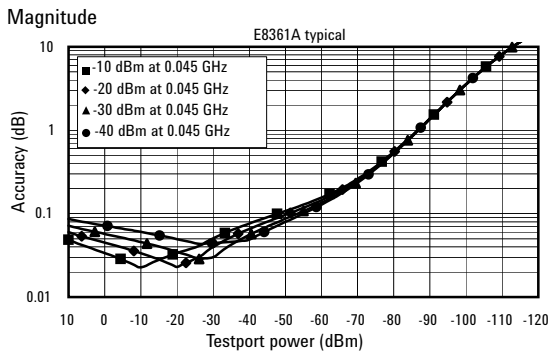

1. Dynamic accuracy is verified with the following measurements: compression over reference frequency, IF linearity at a single frequency of 1.195 GHz and a reference level of -20 dBm for an input power range of 0 to -120 dBm.

E8361A

Test port input *continued*

Dynamic accuracy (specification)¹

Applies to input ports 1 and 2, accuracy of the test port input power reading relative to the reference input power level. Also applies to the following conditions:

- IF bandwidth = 10 Hz

Note: If the power is set above maximum specified leveled power, the test port output signal may show non-linear effects that are dependent on the DUT.

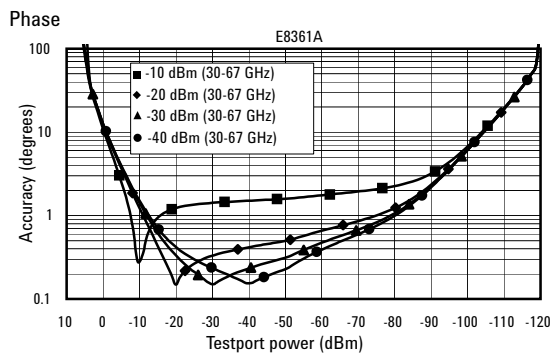
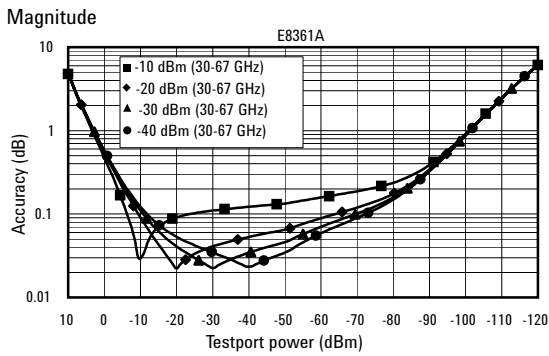

1. Dynamic accuracy is verified with the following measurements: compression over frequency, IF linearity at a single frequency of 1.195 GHz and a reference level of -20 dBm for an input power range of 0 to -120 dBm.

E8361A

Test port input *continued*

Dynamic accuracy (specification)¹

Applies to input ports 1 and 2, accuracy of the test port input power reading relative to the reference input power level. Also applies to the following conditions:

- IF bandwidth = 10 Hz

Note: If the power is set above maximum specified leveled power, the test port output signal may show non-linear effects that are dependent on the DUT.

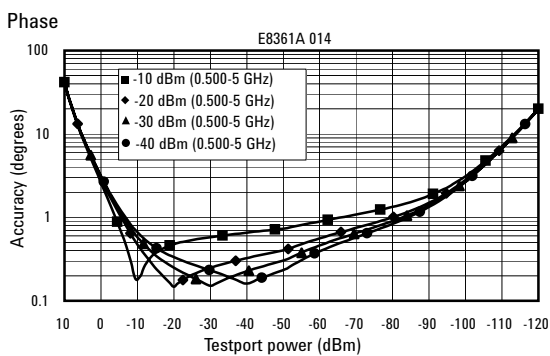
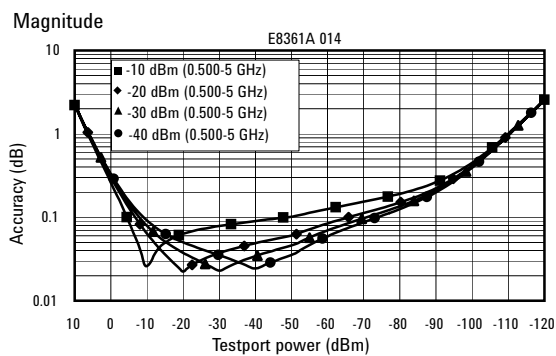

1. Dynamic accuracy is verified with the following measurements: compression over frequency, IF linearity at a single frequency of 1.195 GHz and a reference level of -20 dBm for an input power range of 0 to -120 dBm.

E8361A

Test port input *continued*

Dynamic accuracy (specification)¹

Applies to input ports 1 and 2, accuracy of the test port input power reading relative to the reference input power level. Also applies to the following conditions:

- IF bandwidth = 10 Hz

Note: If the power is set above maximum specified leveled power, the test port output signal may show non-linear effects that are dependent on the DUT.

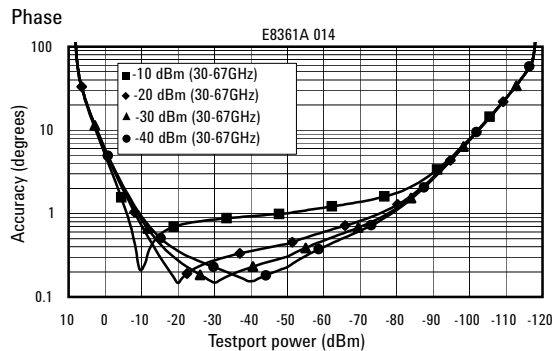
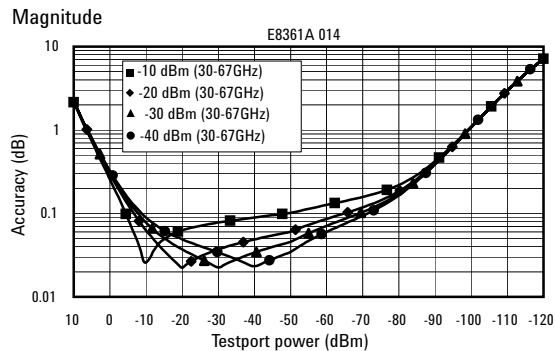
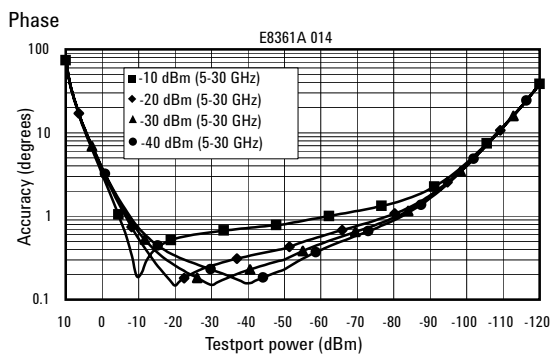
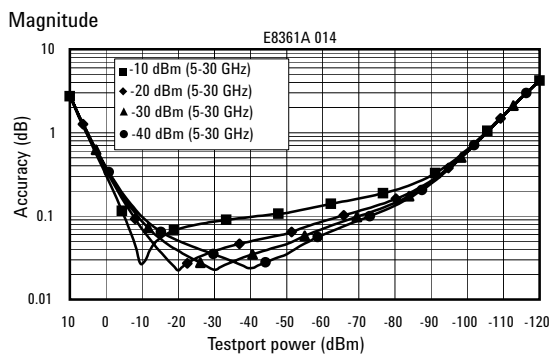

1. Dynamic accuracy is verified with the following measurements: compression over frequency, IF linearity at a single frequency of 1.195 GHz and a reference level of -20 dBm for an input power range of 0 to -120 dBm.

Microwave PNA Series

General information

Description	Supplemental information
System IF bandwidth range	1 Hz to 40 kHz, nominal
RF connectors	
E8362B	3.5 mm (male), 50 Ω , (nominal), center pin recession flush to .002 in. (characteristic)
E8363/4B	2.4 mm (male), 50 Ω , (nominal), center pin recession flush to .002 in. (characteristic)
E8361A	1.85 mm (male), 50 Ω , (nominal), center pin recession flush to .002 in. (characteristic)
Display	8.4 in diagonal color active matrix LCD; 640 (horizontal) x 480 (vertical) resolution; 59.83 Hz vertical refresh rate; 31.41 Hz horizontal refresh rate
	A display is considered faulty if: <ul style="list-style-type: none"> • A complete row or column of "stuck" or "dark" pixels. • More than six "stuck on" pixels (but not more than three green) or more than 0.002% of the total pixels are within the LCD specifications. • More than twelve "dark" pixels (but no more than seven of the same color) or more than 0.004% of the total pixels are within the LCD specifications. • Two or more consecutive "stuck on" pixels or three or more consecutive "dark" pixel (but no more than one set of two consecutive dark pixels) • "Stuck on" of "dark" pixels less than 6.5 mm apart (excluding consecutive pixels)
Display range	
Magnitude	± 200 dB (at 20 dB/div), max
Phase	$\pm 500^\circ$, max
Polar	10 pico units, min; 1000 units, max
Display resolution	
Magnitude	0.001 dB/div, min
Phase	0.01 $^\circ$ /div, min
Marker resolution	
Magnitude	0.001 dB, min
Phase	0.01 $^\circ$, min
Polar	0.01 mUnit, min; 0.01 $^\circ$, min
CPU	Intel [®] 1.1 GHz Pentium [®] M with 1 GByte RAM
Line power (single phase)	
Frequency	50/60/400 Hz for 100 to 120 V, 50/60 Hz for 220 to 240 V (Power supply is auto switching.)
Max	350 Watts
General environmental	
EMC	Complies with European EMC directive 89/336/EEC, amended by 93/68/EEC <ul style="list-style-type: none"> • IEC/EN 61326 • CISPR Pub 11 Group 1, class A • AS/NZS CISPR II:2002 • ICES/NMB-001
Safety	Complies with European Low Voltage Directive 73/23/EEC, amended by 93/68/EEC <ul style="list-style-type: none"> • IEC/EN 61010-1:2001 • Canada: CSA C22.2 No. 61010-1:2001 • USA: UL 61010-1
Operating environment	
Temperature	0 to +40 $^\circ$ C; Instrument powers up, phase locks, and displays no error messages within this temperature range. (Except for 'source unlevelled' error message that may occur at temperature outside the specified performance temperature range of 25 $^\circ$ C, ± 5 $^\circ$ C.)
Error-corrected temperature range	System specifications valid from 23 $^\circ$ C, ± 3 $^\circ$ C, with less than 1 $^\circ$ C deviation from the calibration temperature
Relative humidity	Type-tested, 0 to 95% at 40 $^\circ$ C, non condensing
Altitude	0 to 4600 m (15,000 ft)

Microwave PNA Series

General information *continued*

Description	Supplemental information		
Non-operating storage environment			
Temperature	-40 to +70 °C		
Cabinet dimensions			
	Height	Width	Depth
Excluding front and rear panel hardware and feet	267 mm 10.50 in	426 mm 16.75 in	427 mm 16.80 in
As shipped - includes front panel connectors, rear panel bumpers, and feet.	280 mm 11.00 in	435 mm 17.10 in	470 mm 18.50 in
As shipped plus handles	280 mm 11.00 in	458 mm 18.00 in	501 mm 19.70 in
As shipped plus rack mount flanges	280 mm 11.00 in	483 mm 19.00 in	470 mm 18.50 in
As shipped plus handles and rack mount flanges	280 mm 11.00 in	483 mm 19.00 in	501 mm 19.70 in
Weight			
Net	29 kg (64 lb), nom.		
Shipping	36 kg (80 lb), nom.		

Microwave PNA Series

Rear panel

Description	Supplemental information
External trigger rear panel I/O (typical)	
Trigger inputs/outputs	BNC(f), TTL/CMOS compatible
Trigger input	
Function	Measurement of next point, next channel, or next group of channels
Source	Aux I/O (pin 19) or I/O 1 (BNC (f) connector)
Signal levels	TTL-compatible
Input impedance	5 k Ω nominal
Minimum trigger width	1 μ s
Trigger modes	High or low level; positive or negative edge
Trigger delay range	0 to 1 sec
Trigger delay resolution	6 μ s (IF bandwidth \geq 15 kHz) or 6.2 μ s (IF bandwidth <15 kHz)
Trigger output	
Function	Generate pulse before or after measurement (only active when trigger type is external)
Source	I/O 2 (BNC (f) connector)
Signal levels	TTL-compatible
Trigger polarity	Positive or negative edge
Pulse width	1 μ s
Option H11 rear panel I/O (typical)	
External IF inputs	
Function	Allows use of external IF signals from remote mixers, bypassing the PNA's first converters
Connectors	BNC (f), for B, R2, R1, A receivers
Input frequency	8.33 MHz
Input impedance	50 Ω nominal
RF damage level	-20 dBm
DC damage level	25 Volts
0.1 dB compression point	-27 dBm
Test Set Drivers	
Function	Used for driving remote mixers
Connectors	SMA (f) for RF and LO outputs
RF, LO output frequency range	1.7 to 20 GHz
RF output power levels	+5 to -16 dBm, depending on frequency ¹
LO output power levels	-7 to -16 dBm, depending on frequency
Pulse inputs (IF gates)²	
Function	Internal receiver gates used for point-in-pulse and pulse-profile measurements
Connectors	BNC (f), for B, R2, R1, A receivers
Input impedance	1 k Ω nominal
Minimum pulse width	20 ns for less than 1 dB deviation from theoretical performance ³
DC damage level	5.5 Volts
Signal levels	TTL; 0 V (off), +5 V (on) nominal

1. Measured at -5 dBm test port power.

2. Pulse input connectors are operational only with Option H08 (Pulsed Measurement Capability) enabled.

3. Based on deviation from signal reduction equation:

$$\text{Signal Reduction (dB)} = 20\log_{10}(\text{Duty_cycle}) = 20\log_{10}(\text{pulse_width}/\text{pulse_repetition_interval}).$$

Measured at pulse repetition frequency of 1 MHz.

Microwave PNA Series

Rear panel *continued*

Description	Supplemental information
10 MHz reference in	
Input frequency	10 MHz \pm 10 ppm, typ.
Input power	-15 to +20 dBm, typ.
Input impedance	200 Ω , nom.
10 MHz reference out	
Output frequency	10 MHz \pm 10 ppm, typ.
Signal type	Sine wave, typ.
Output power	10 dB \pm 4 dB into 50 Ω , typ.
Output impedance	50 Ω , nom.
Harmonics	< -40 dBc, typ.
Test set I/O	25-pin D-sub; available for external test set control
Handler I/O	36-pin, parallel I/O port; all input/output signals are default set to negative logic; can be reset to positive logic via GPIB command
Auxiliary I/O	25-pin D-sub male connector; analog and digital I/O
Bias tee inputs	
Connectors	BNC (f), for port 1 and port 2
Maximum voltage	\pm 40 V DC
Maximum current	\pm 200 mA with no degradation of RF specifications
Fuse	500 mA, bi-pin style
The following connectors/connections are located on the Intel [®] 1.1 GHz Pentium [®] M CPU	
VGA video output	15-pin mini D-Sub; Drives VGA compatible monitors
GPIB	Two ports: dedicated controller and dedicated talker/listener 24-pin D-sub (Type D-24), female; compatible with IEEE-488
USB port	1 port on front panel and 4 ports on rear panel.
LAN	10/100 BaseT Ethernet; 8-pin configuration auto selects between the two data rates

Microwave PNA Series

Measurement throughput summary

Cycle time vs. IF bandwidth ¹

Instrument state: preset condition, 201 points, CF = 28 GHz, Span = 100 MHz, correction off. Add 21 ms for display on. Cycle time includes sweep and re-trace time.

IF bandwidth (Hz)	Cycle time (ms)	Cycle time (ms) Option 080 enabled
40,000	11	100
35,000	12	101
30,000	13	102
20,000	16	106
10,000	30	127
7,000	38	138
5,000	50	152
3,000	74	182
1,000	274	326
300	694	782
100	1905	2054
30	6091	6355
10	17916	18372

Cycle time vs. number of points ¹

Instrument state: preset condition, 35 kHz IF bandwidth, CF = 28 GHz, Span = 100 MHz, correction off. Add 21 ms for display on. Cycle time includes sweep and re-trace time.

Number of points	Cycle time (ms)
3	6
11	6
51	7
101	9
201	12
401	18
801	30
1601	55
16,001	497

Cycle time (ms) ^{1,2}

	Number of points			
	201	401	1601	16,001
Start 28 GHz, stop 30 GHz, IFBW = 35 kHz				
Uncorrected and one-port cal	12	19	55	503
Two-port cal	29	44	124	1112
Start 10 MHz, stop 10 GHz, IFBW = 35 kHz				
Uncorrected and one-port cal	86	93	121	583
Two-port cal	179	199	267	1301
Start 10 MHz, stop 20 GHz, IFBW = 35 kHz				
Uncorrected and one-port cal	126	130	153	597
Two-port cal	264	275	335	1321
Start 10 MHz, stop 40 GHz, IFBW = 35 kHz				
Uncorrected and one-port cal	185	190	213	621
Two-port cal	382	401	459	1374
Start 10 MHz, stop 50 GHz, IFBW = 35 kHz				
Uncorrected and one-port cal	210	216	243	643
Two-port cal	436	450	522	1405
Start 10 MHz, stop 67 GHz, IFBW = 35 kHz				
Uncorrected	244	254	300	645
Corrected	502	524	591	1423

1. Typical performance.

2. Includes sweep time, retrace time and band-crossing time. Analyzer display turned off with DISPLAY:ENABLE OFF. Add 21 ms for display on.
Data for one trace (S11) measurement.

Frequency Converter Application (Option 083) cycle time for fixed-IF measurements (s)¹

	Number of points		
	101	201	401
Stimulus start = 1 GHz, stop = 11 GHz, IFBW = 35 kHz			
Response = 70 MHz, trace = SC21, cal = SMC_2P			
Hardware trigger	8.5	17	34
Software trigger	31	62	124

Data transfer time (ms)²

	Number of points			
	201	401	1601	16,001
SCPI over GPIB				
(program executed on external PC)				
32-bit floating point	7	12	43	435
64-bit floating point	12	22	84	856
ASCII	64	124	489	5054
SCPI (program executed in the analyzer)				
32-bit floating point	1	2	3	30
64-bit floating point	2	2	4	40
ASCII	29	56	222	2220
COM (program executed in the analyzer)				
32-bit floating point	1	1	1	6
Variant type	1	2	6	68
DCOM over LAN				
(program executed on external PC)				
32-bit floating point	1	1	2	121
Variant type	3	6	19	939

1. Typical performance, using an Agilent PSG (E8257D) signal generator for the external LO source.

2. Typical performance.

Microwave PNA Series

Measurement capabilities

Number of measurement channels

Thirty-two independent measurement channels. A measurement channel is coupled to stimulus settings including frequency, IF bandwidth, power level, and number of points.

Number of display windows

Up to 16 display windows. Each window can be sized and re-arranged. Up to four measurement channels can be displayed per window.

Number of traces

Up to four active traces and four memory traces per window. Measurement traces include S-parameters, as well as relative and absolute power measurements.

Measurement choices

S11, S21, S12, S22, A/R1, A/R2, A/B, B/R1, B/R2, B/A, R1/A, R1/B, R1/R2, R2/A, R2/B, R2/R1, A, B, R1, R2

Formats

Log or linear magnitude, SWR, phase, group delay, real and imaginary, Smith chart, polar.

Data markers

Ten independent markers per trace. Reference marker available for delta marker operation. Marker formats include log or linear magnitude, phase, real, imaginary, SWR, delay, $R + jX$, and $G + jB$.

Marker functions

Marker search

Maximum value, minimum value, target, next peak, peak right, peak left, target, and bandwidth with user-defined target values

Marker-to functions

Set start, stop, and center to active marker stimulus value; set reference to active marker response value; set electrical delay to active marker phase response value.

Trace statistics

Calculates and displays mean, standard deviation and peak-to-peak deviation of the data trace.

Tracking

Performs new search continuously or on demand.

Source control

Measured number of points per sweep

User definable from 2 to 16,001.

Sweep type

Linear, CW (single frequency), power or segment sweep.

Segment sweep

Create a segment sweep, which consists of frequency subsweeps, called segments. For each segment, define independent power levels, IF bandwidth, and sweep time. The number of segments is limited only by the combined number of data points for all segments in a sweep. The combined number of data points for all segments in a sweep cannot exceed 16001.

Sweep trigger

Set to continuous, hold, single, or group sweep with internal or external trigger.

Power

Power slope can be set in dBm/GHz. Control the test port signal by setting the internal attenuator of the test set over a 60-dB range.

Trace functions

Display data

Display current measurement data, memory data, or current measurement with measurement and memory data simultaneously.

Trace math

Vector addition, subtraction, multiplication or division of current linear measurement values and memory data.

Display annotations

Start/stop, center/span, or CW frequency, scale/div, reference level, marker data, warning and caution messages, trace status, and pass/fail indication.

Title

Add custom titles (50 characters maximum) to the display. Titles will be printed when making hardcopies of displayed measurements.

Autoscale

Automatically selects scale resolution and reference value to center the trace.

Electrical delay

Offset measured phase or group delay by a defined amount of electrical delay, in seconds.

Phase offset

Offset measured phase or group delay by a defined amount in degrees.

Microwave PNA Series

Automation

	GPIB	LAN	Internal
SCPI	X	X	X
COM/DCOM		X	X

Methods

Controlling via internal analyzer execution

Write applications that can be executed from within the analyzer via COM (component object model) or SCPI standard-interface commands. These applications can be developed in a variety of languages, including Visual Basic, Visual C++, Agilent VEE, or LabView™ programming languages.

Controlling via GPIB

The GPIB interface operates to IEEE 488.2 and SCPI standard-interface commands. The analyzer can either be the system controller, or talker/listener.

Controlling via LAN

The built-in LAN interface and firmware support data transfer and control via direct connection to a 10 Base-T network.

SICL/LAN Interface

The analyzer's support for SICL (standard instrument control library) over the LAN provides control of the network analyzer using a variety of computing platforms, I/O interfaces, and operating systems. With SICL/LAN, the analyzer is controlled remotely over the LAN with the same methods used for a local analyzer connected directly to the computer via a GPIB interface.

DCOM Interface

The analyzer's support for DCOM (distributed component object model) over the LAN provides control of the network analyzer using a variety of platforms. DCOM acts as an interface to the analyzer for external applications. With DCOM, applications can be developed or executed from an external computer. During development, the application can interface to the analyzer over the LAN through the DCOM interface. Once development is completed, the application can be distributed to the analyzer and interfaced using COM.

Microwave PNA Series

Data accuracy enhancement

Measurement calibration

Measurement calibration significantly reduces measurement uncertainty due to errors caused by system directivity, source and load match, tracking and crosstalk. Full two-port calibration removes all the systematic errors to obtain the most accurate measurements.

Calibration types available

Frequency response

Simultaneous magnitude and phase correction of frequency response errors for either reflection or transmission measurements.

Response and isolation

Compensates for frequency response and directivity (reflection) or frequency response and crosstalk errors.

One-port calibration

Uses test set port 1 or port 2 to correct for directivity, frequency response and source match errors.

Two-port calibration

Compensates for directivity, source match, reflection frequency response, load match, transmission frequency response and crosstalk. Crosstalk calibration can be omitted.

Mixer Calibration

Scalar-mixer calibration:

Scalar-mixer calibration corrects the conversion loss for input port source match, output port load match, absolute input or source power, and absolute output or receiver power. Scalar-mixer calibrations also corrects the input match measurements (S11) for input port directivity, frequency response and source match at the input frequencies and corrects the output match measurement (S22) for output directivity, frequency response and source match at the output frequencies.

Vector-mixer calibration:

At the input frequencies of the mixer, the vector-mixer calibration compensates for directivity, source match, and reflection frequency response. At the output frequencies of the mixer, the vector-mixer calibration compensates for directivity, load match, and reflection frequency response. Frequency-translated transmission response is compensated by using a characterized calibration mixer. The characterization of the calibration mixer is part of the calibration process.

TRL/TRM calibration

Compensates for directivity, reflection and transmission frequency response and crosstalk in both forward and reverse directions. Provides the highest accuracy for both coaxial and non-coaxial environments, such as on-wafer probing, in-fixture or waveguide measurements.

Interpolated error correction

With any type of accuracy enhancement applied, interpolated mode recalculates the error coefficients when the test frequencies are changed. The number of points can be increased or decreased and the start/stop frequencies can be changed, but the resulting frequency range must be within the original calibration frequency. System performance is not specified for measurements with interpolated error correction applied.

Velocity factor

Enters the velocity factor to calculate the equivalent electrical length.

Reference plane extension

Redefine the plane-of-measurement reference to other than port 1 or port 2.

Storage

Internal hard disk drive

Store and recall binary instrument states and calibration data on 10 GB, minimum, internal hard drive. Instrument data can also be saved in ASCII (including S2P) format. All files are MS-DOS®-compatible. Instrument states include all control settings, active limit lines, active list frequency tables, memory trace data.

Disk drive

Instrument data, instrument states, and calibration data can be stored on internal 3.5-in, 1.4 MB floppy disk in MS-DOS-compatible format.

Data hardcopy

Printouts of instrument data are directly produced on any printer with the appropriate Windows® 2000 printer driver. The analyzer provides USB, Centronics (parallel), serial and LAN interfaces.

Microwave PNA Series

System capabilities

Familiar graphical user interface

The PNA Series employs a graphical user interface based on Windows 2000. There are two fundamental ways to operate the instrument manually: you can use a hardkey interface, or use drop-down menus driven from a mouse (or another standard USB pointing device). Hardkey navigation brings up active toolbars that perform most of the operations required to configure and view measurements. Front-panel navigation keys allow for use of the instrument without a mouse. In addition, mouse-driven pull-down menus provide easy access to both standard and advanced features. Both methods employ dialog boxes to display all the choices needed to make measurement set-ups.

Built-in information system

Embedded documentation provides measurement assistance in five different languages (English, Chinese, French, German, Japanese, and Spanish). A thorough index of help topics and context-sensitive help is available from dialog boxes.

Limit lines

Define test limit lines that appear on the display for go/no go testing. Lines may be any combination of horizontal, sloping lines, or discrete data points.

Time-domain (Option 010)

With the time-domain option, data from transmission or reflection measurements in the frequency domain are converted to the time domain using a Fourier transformation technique (chirp Z) and presented on the display. The time-domain response shows the measured parameter value versus time. Markers may also be displayed in electrical length (or physical length if the relative propagation velocity is entered).

Time stimulus modes

Two types of time excitation stimulus waveforms can be simulated during the transformations, a step and an impulse.

Low-pass step

This stimulus, similar to a traditional time-domain reflectometer (TDR) stimulus waveform, is used to measure low-pass devices. The frequency-domain data should extend from DC (extrapolated value) to a higher value. The step response is typically used for reflection measurements only.

Low-pass impulse

This stimulus is also used to measure low-pass devices. The impulse response can be used for reflection or transmission measurements.

Bandpass impulse

The bandpass impulse stimulates a pulsed RF signal (with an impulse envelope) and is used to measure the time-domain response of band-limited devices. The start and stop frequencies are selectable by the user to any values within the limits of the test set used. Bandpass time-domain responses are useful for both reflection and transmission measurements.

Time-domain range

The "alias-free" range over which the display is free of response repetition depends on the frequency span and the number of points. Range, in nanoseconds, is determined by: $\text{Time-domain range} = (\text{number of points} - 1) / \text{frequency span [in GHz]}$

Range resolution

The time resolution of a time-domain response is related to range as follows: $\text{Range resolution} = \text{time span} / (\text{number of points} - 1)$

Windows

The windowing function can be used to modify (filter) the frequency-domain data and thereby reduce over-shoot and ringing in the time-domain response. Kaiser Beta windows are available.

Gating

The gating function can be used to selectively remove reflection or transmission time-domain responses. In converting back to the frequency-domain the effects of the responses outside the gate are removed.

Configurable test set (Option 014)

With the configurable test set option, front panel access loops are provided to the signal path between the source output and coupler input.

Extended dynamic range configuration

Reverse the signal path in the coupler and bypass the loss typically associated with the coupled arm. Change the port 2 switch and coupler jumper configurations to increase the forward measurement dynamic range. When making full two-port error corrected measurements, the reverse dynamic range is degraded by 12 to 15 dB.

High power measurement configuration

Add external power amplifier(s) between the source output and coupler input to provide up to +30 dBm of power at the test port(s). Full two-port error correction measurements possible. When the DUT output is expected to be greater than +30 dBm, measure directly at the B input and use an external fixed or step attenuator to prevent damage to the receiver. For measurements greater than +30 dBm, add external components such as couplers, attenuators, and isolators.

Frequency-offset (Option 080)

This option enables the PNA Series microwave network analyzers to set the source frequency independently from where the receivers are tuned. This ability is important for two general classes of devices: mixers (and converters) and amplifiers. For frequency-translating devices like mixers or converters, frequency-offset capability is necessary for conversion loss/gain measurements (both amplitude and phase), since, by definition, the input and output frequency of the DUT are different. For amplifier measurements, frequency offset capability is required to measure amplifier harmonics or when using the internal source as one of the stimuli of an IMD measurement. Option 080 provides a very basic user interface. The user may enter multiplier and offset values to describe how the instrument's receivers track the source frequency. While flexible, the user interface requires the user to calculate the correct values. The frequency-converter application (Option 083) provides a much more intuitive and easy-to-use user interface, designed specifically for mixer and converter measurements.

Reference channel switch (Option 081)

Option 081 adds a solid-state internal RF transfer switch in the R1 reference-receiver path. The switch allows the instrument to easily switch between standard S-parameter (non-frequency-offset) measurements and frequency-offset measurements such as relative phase or absolute group delay that require an external reference mixer. The user can set the switch manually or remotely, but it is best used with the frequency-converter application (Option 083), where it is controlled automatically during the vector-mixer calibration procedure.

Scalar-calibrated converter measurements (Option 082)

With a simple setup and calibration, this application provides the highest accuracy for conversion-loss (or gain) measurements by combining one-port and power-meter calibrations to remove mismatch errors. Option 080 required.

Frequency-converter application (Option 083)

The frequency-converter application adds an intuitive and easy-to-use user interface, advanced calibration choices that provide exceptional amplitude and phase accuracy, and control of external signal sources for use as local oscillators. A graphical set-up dialog box lets you quickly set up the instrument for single or dual conversion devices. This set-up screen also helps you calculate and choose where mixing and image products will fall.

Embedded LO measurements (Option 084)

Advanced software tuning that provides absolute group delay of converters with embedded LOs without the need for access to a common reference signal. The measurement result is the same as locking the DUT to the reference mixer LO. Options 080 and 083 required.

Extended power range and bias-tees (Option UNL)

Adds two 60 dB step attenuators (50 dB for E8361A) and two bias-tees. A step attenuator and bias-tee set is inserted between the source and test port one and another set between the source and test port two.

Add receiver attenuator (Option 016)

A 35 dB attenuator with 5 dB steps (50 dB attenuator with 10 dB steps for E8361A only) is added between both test ports and their corresponding receiver. See page 53 for a basic block diagram.

IF Access (Option H11)

Provides hardware to enable antenna, point-in-pulse, and pulse-profile measurements, as well as broadband millimeter-wave measurements to 110 GHz, and banded millimeter-wave measurements to 325 GHz. For each of the microwave PNA's measurement receivers, IF gates (enabled with pulsed-RF measurement capability Option H08) and external IF inputs are added. In addition, access to the PNA's internal RF and LO sources is provided for remote-mixing applications. For basic antenna measurements, only Option H11 is necessary. Pulsed-antenna applications also require the pulsed-measurement capability (Option H08). Millimeter-wave measurements also require an N5260A millimeter-wave test set controller.

Pulsed-RF measurement capability (Option H08)

Provides software to set up and control pulsed-RF measurements with point-in-pulse and pulse-profile capability. The software sets the coefficients of the PNA's digital-IF filter to null out unwanted spectral components, enables the IF gates provided with IF access (Option H11), and controls the Agilent 81110A family of pulse generators. The software can be run on the PNA or an external computer, and a ".dll" file containing the IF-filter algorithm is included for automated pulsed-RF testing.

4-port measurement application (Option 550)

Enables full 4-port error correction and differential measurements on a 2-port network analyzer. External test set must be connected. User installable.

N-port measurement application (Option 551)

Enables full N-port error correction and differential measurements on a 2-port network analyzer. External test set must be connected. User installable.

Commercial calibration certificate with test data (Option UK6)

Complete set of measurements which tests unit to manufacturer's published specifications. Includes calibration label, calibration certificate, and data report. Conforms to ISO 9001.

ISO 17025 compliant calibration (Option 1A7)

Complete set of measurements which tests unit to manufacturer's published specifications. Includes calibration label, ISO 17025 calibration certificate, and data report, measurement uncertainties and guardbands on all customer specifications. Conforms to ISO 17025 and ISO 9001.

ANSI Z540 compliant calibration (Option A6J)

Complete set of measurements which tests unit to manufacturer's published specifications. Includes pre and post-adjustment data with measurement uncertainty information compliant to the ANSI/NCSL Z540 standard.

Supplemental performance

Minimum reference channel input level
(Option 080 disabled): -35 dBm

Microwave PNA Series

Simplified test set block diagram

Standard power range

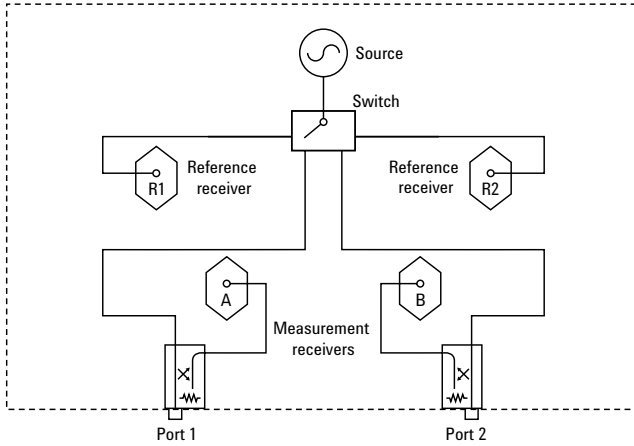

Extended power range and bias-tees (Option UNL)

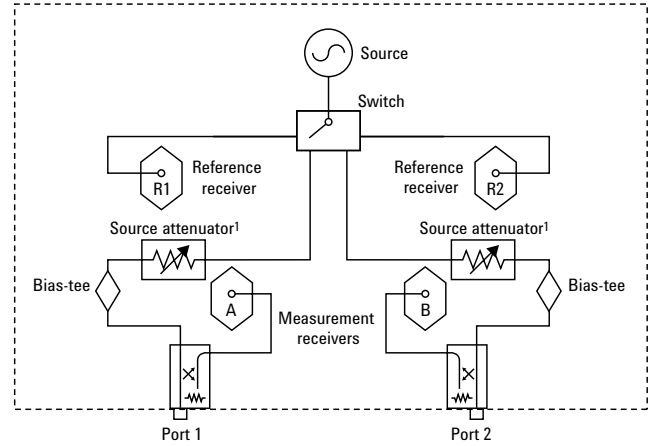

Configuration test set (Option 014)

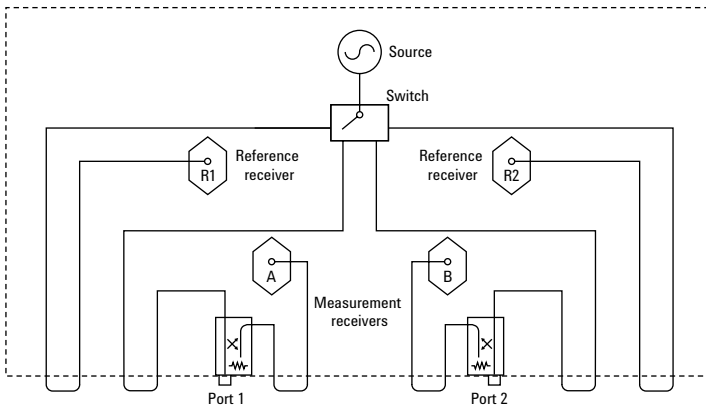

Configurable test set with extended power range and bias-tees (Option UNL and 014)

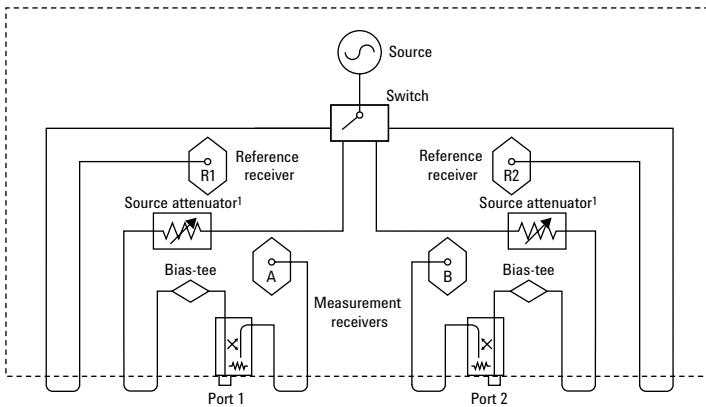

1. Source attenuator for E8362/3/4B is 60 dB in 10 dB steps. Source attenuator for E8361A is 50 dB in 10 dB steps.

Fully optioned (Options 014, UNL, 016, 080, 081)

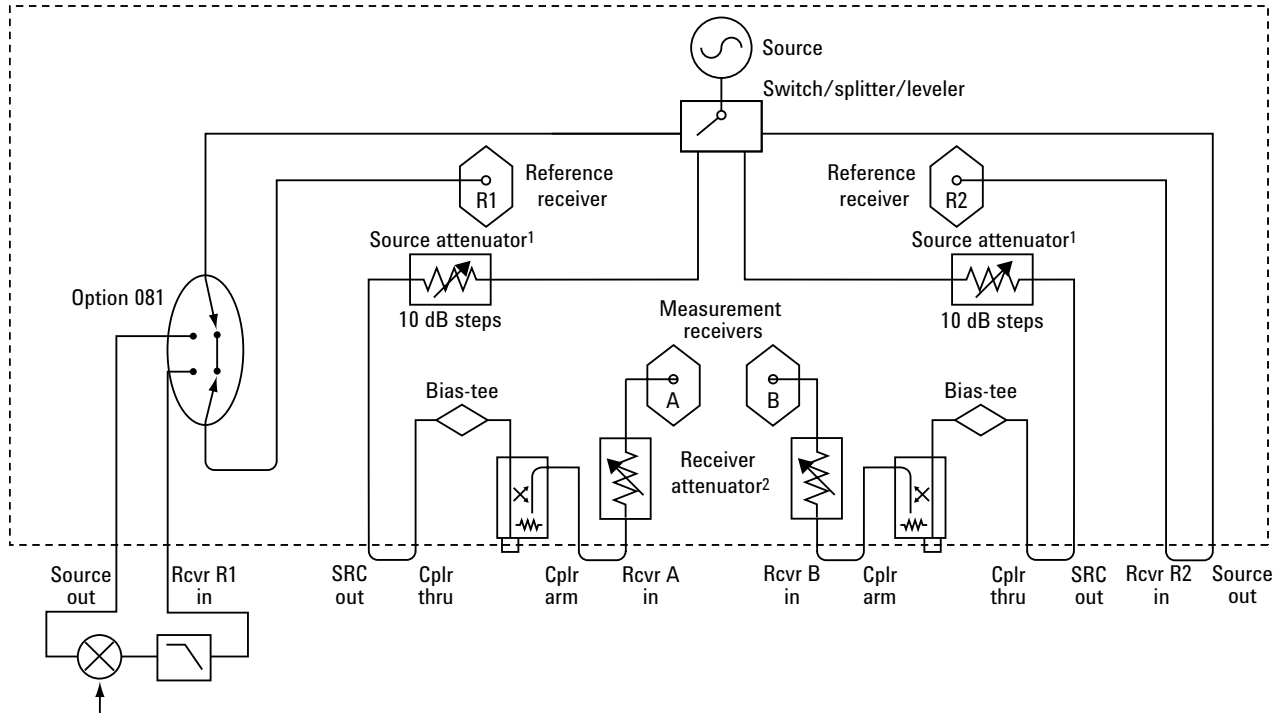

Fully optioned pulse, antenna, or mm-wave configuration (Options 014, UNL, 016, 080, 081, H11)

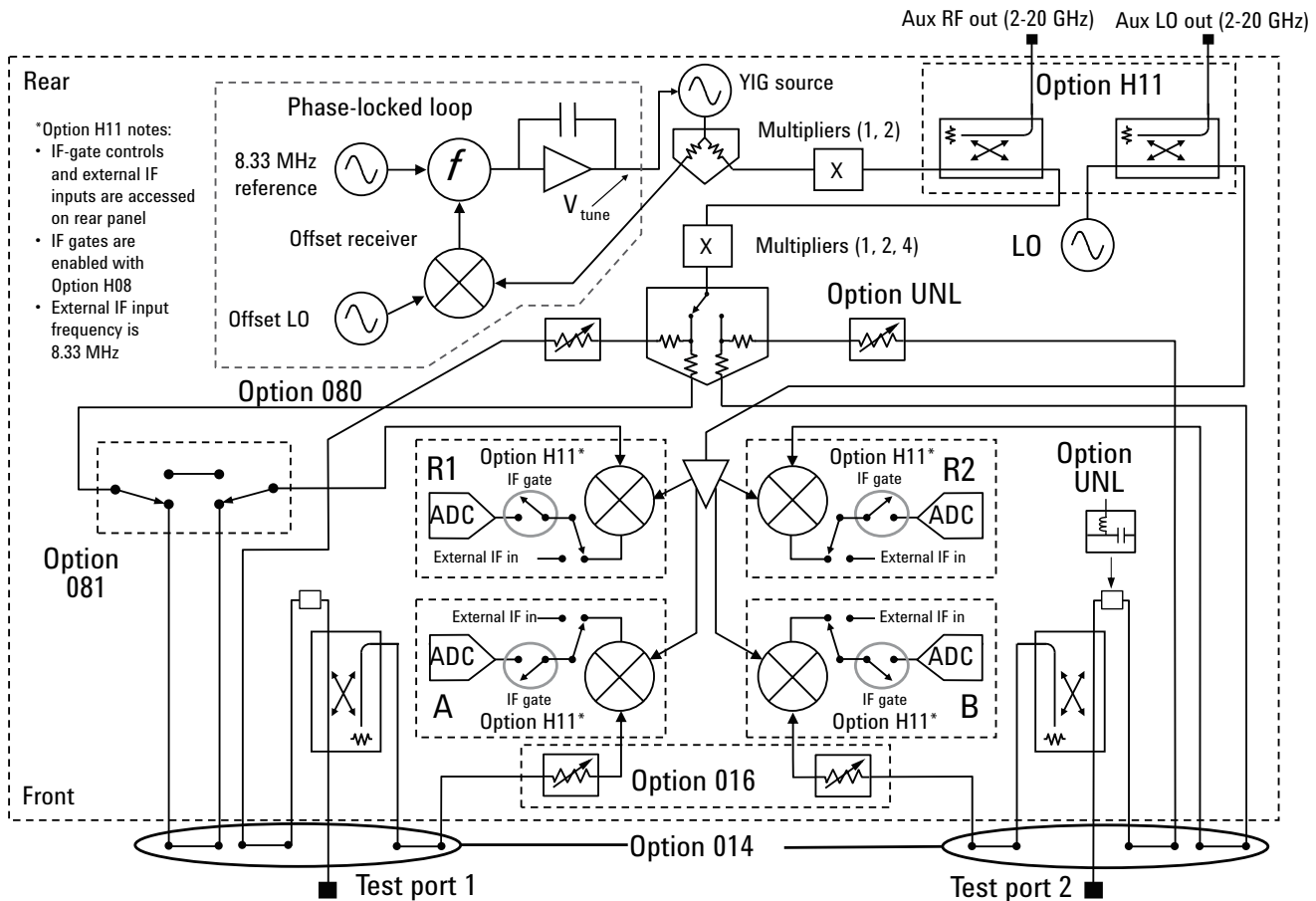

- *Option H11 notes:
- IF-gate controls and external IF inputs are accessed on rear panel
 - IF gates are enabled with Option H08
 - External IF input frequency is 8.33 MHz

1. Source attenuator for E8362/3/4B is 60 dB in 10 dB steps. Source attenuator for E8361A is 50 dB in 10 dB steps.
 2. Receiver attenuator for E8362/3/4B is 35 dB in 5 dB steps. Receiver attenuator for E8361A is 50 dB in 10 dB steps.

Ordering guide for PNA series

Network analyzers

This guide is intended to assist you in the ordering process. For detailed ordering information, refer to the *PNA Series Microwave Network Analyzer Configuration Guide* (literature number 5988-7989EN).

PNA Series microwave network analyzers¹

E8362B	10 MHz to 20 GHz
E8363B	10 MHz to 40 GHz
E8364B	10 MHz to 50 GHz
E8361A	10 MHz to 67 GHz

Options

To add options to a product, order the corresponding item number.

Description	For E8362B item number	For E8363B item number	For E8364B item number	For E8361A ² item number	Additional information
Test set					
Option 014 • Configurable test set	E8362B-014	E8363B-014	E8364B-014	E8361A-014	
Power configuration					
Option UNL • Extended power range and bias-tees	E8362B-UNL	E8364B-UNL	E8364B-UNL	E8361A-UNL	E8361A only, requires 014
Option 016 • Add receiver attenuators	E8362A-016	E8364A-016	E8364A-016	E8361A-016	E8361A only, requires 014 and UNL
CPU RAM					
Option 022 • Extended memory	E8362A-022	E8364A-022	E8364A-022	E8361A-022	
Non-linear measurements					
Option 080 • Frequency offset	E8362A-080	E8364A-080	E8364A-080	E8361A-080	Requires 014
Option 081 • Reference receiver switch	E8362A-081	E8364A-081	E8364A-081	E8361A-081	Requires 014, 080
Option 083 • Frequency-converter measurement application	E8362A-083	E8364A-083	E8364A-083	E8361A-083	Requires 014, 080, and 081 (E8361A only requires 014, 080) includes GPIB to USB interface (82357A)
Option H11 • IF access (for antenna and pulsed-RF measurements)	E8362B-H11	E8363B-H11	E8364B-H11	E8361A-H11	Requires 014, 080, 081, and UNL
Option H08 • Pulsed-RF measurement capability	E8362B-H08	E8363B-H08	E8364B-H08	E8361A-H08	
Measurement features					
Option 010 • Time-domain capability	E8362A-010	E8363A-010	E8364A-010	E8361A-010	
Option 550 ³ • 4-port measurement application	E8362B-550	E8363B-550	E8364B-550	E8361A-550	
Accessories					
Option 1CM • Rack mount kit without handles	E8362A-1CM	E8363A-1CM	E8364A-1CM	E8361A-1CM	
Option 1CP • Rack mount kit with handles	E8362A-1CP	E8363A-1CP	E8364A-1CP	E8361A-1CP	
N4688A • USB CD R/W drive	N4688A	N4688A	N4688A	N4688A	
N4689A • USB Hub	N4689A	N4689A	N4689A	N4689A	
Calibration documentation					
Option 1A7 • ISO 17025 compliant calibration	E8362B-1A7	E8363B-1A7	E8364B-1A7	Available soon	
Option UK6 • Commercial calibration certificate with test data	E8362A-UK6	E8363A-UK6	E8364A-UK6	E8361A-UK6	
Option A6J • ANSI Z540 compliant calibration	E8362B-A6J	E8363B-A6J	E8364B-A6J	E8361A-A6J	

Note: Item numbers may not correspond to product model number. For example, to order the time-domain option on the E8362B, the correct item number to order is E8362A-010.

Warranty and service

One and three year warranty and service plans are available at the time of instrument purchase. The N5250A microwave 110 GHz system carries a full one-year on-site warranty (where available).

Calibration

Three year calibration plans are available at time of instrument purchase.

1. Not all models are available in all countries.
 2. E8361AH11 enables E8361A to cover 10 MHz to 110 GHz frequency range.
 3. External test set must be connected.

Test port cable specifications

	Connector Type (Test port to device)	Frequency (GHz)	Length ² cm (inch)	Return loss	Insertion loss (dB) (f in GHz)	Stability ^{1,2} ±magnitude	±Phase (degrees)
Single cables for 8719 and 8720 (3.5 mm)							
85131C semi-rigid cable	3.5 mm ³ to PSC-3.5 mm (f)	DC to 26.5	81 (32)	≥17 dB	0.43 √f +0.3 (2.5 dB at f _{max})	<0.06 dB	0.16 (f) +0.5
85131E flexible cable	3.5 mm ³ to PSC-3.5 mm (f)	DC to 26.5	96.5 (38)	≥16 dB	0.35 √f +0.3 (2.1 dB at f _{max})	<0.22 dB	0.16 (f) +0.8
85132C semi-rigid cable	3.5 mm ³ to 7 mm	DC to 18	81 (32)	≥17 dB	0.35 √f +0.3 (1.8 dB at f _{max})	<0.06 dB	0.16 (f) +0.5
85132E flexible cable	3.5 mm ³ to 7 mm	DC to 18	97.2 (38.25)	≥17 dB	0.35 √f +0.3 (1.8 dB at f _{max})	<0.22 dB	0.16 (f) +0.8
Cable sets for 8719 and 8720 (3.5 mm)							
85131D semi-rigid cable set	3.5mm ³ to PSC-3.5 mm (f) or 3.5 mm (m)	DC to 26.5	53 (21)	≥16 dB	0.30 √f +0.2 (1.8 dB at f _{max})	<0.06 dB	0.16 (f) +0.5
85131F flexible cable set	3.5 mm ³ to PSC-3.5 mm (f) or 3.5 mm (m)	DC to 26.5	53 (21)	≥16 dB	0.25 √f +0.2 (1.5 dB at f _{max})	<0.12 dB	0.13 (f) +0.5
85132D semi-rigid cable set	3.5 mm ³ to 7 mm	DC to 18	53 (21)	≥17 dB	0.25 √f +0.2 (1.3 dB at f _{max})	<0.06 dB	0.16 (f) +0.5
85132F flexible cable set	3.5 mm ³ to 7 mm	DC to 18	53 (21)	≥17 dB	0.25 √f +0.2 (1.3 dB at f _{max})	<0.12 dB	0.13 (f) +0.5
Single cables for 8722 (2.4 mm)							
85133C semi-rigid cable	2.4 mm ³ to PSC-2.4 mm (f)	DC to 50	81 (32)	≥15 dB	0.84 √f +0.3 (5.6 dB at f _{max})	<0.06 dB	0.18 (f)
85133E flexible cable	2.4 mm ³ to PSC-2.4 mm (f)	DC to 50	113 (44)	≥12.5 dB	0.58 √f +0.35 (4.45 dB at f _{max})	<0.25 dB	0.8 +0.16 (f)
85134C semi-rigid cable	2.4 mm ³ to PSC-3.5 mm (f)	DC to 26.5	81 (32)	≥16 dB	0.46 √f +0.3 (2.7 dB at f _{max})	<0.06 dB	0.18 (f)
85134E flexible cable	2.4 mm ³ to PSC-3.5 mm (f)	DC to 26.5	97.2 (38.25)	≥16 dB	0.46 √f +0.3 (2.7 dB at f _{max})	<0.22 dB	0.16 (f) +0.8
85135C semi-rigid cable	2.4 mm ³ to 7 mm	DC to 18	81 (32)	≥17 dB	0.46 √f +0.3 (2.25 dB at f _{max})	<0.06 dB	0.18 (f)
85135E flexible cable	2.4 mm ³ to 7 mm	DC to 18	97.2 (38.25)	≥17 dB	0.46 √f +0.3 (2.25 dB at f _{max})	<0.22 dB	0.16 (f) +0.8

1. Phase stability of semi-rigid/flexible cables is specified with a 90-degree bend and a 4"/3" radius.

2. Cable length and stability are supplemental characteristics.

3. Special rugged female connector specifically for connecting to the network analyzer test port. Does not mate with a standard male connector.

Test port cable specifications *continued*

	Connector Type (Test port to device)	Frequency (GHz)	Length ² cm (inch)	Return loss	Insertion loss (dB) (f in GHz)	Stability ^{1,2} ±magnitude	±Phase (degrees)
Cable sets for 8722D (2.4 mm)							
85133D semi-rigid cable set	2.4 mm ³ to PSC-2.4 mm (f) or 2.4 mm (m)	DC to 50	53 (21)	≥15 dB	0.55 √f +0.2 (3.7 dB at f _{max})	<0.06 dB	0.16 (f)
85133F flexible cable set	2.4 mm ³ to PSC-2.4 mm (f) or 2.4 mm (m)	DC to 50	72 (28)	≥12.5 dB	0.48 √f +0.25 (3.64 dB at f _{max})	<0.17 dB	0.8 + 0.16 (f)
85134D semi-rigid cable set	2.4 mm ³ to PSC-3.5 mm (f) or 3.5 mm (m)	DC to 26.5	53 (21)	≥16 dB	0.31 √f +0.2 (1.8 dB at f _{max})	<0.06 dB	0.18 (f)
85134F flexible cable set	2.4 mm ³ to PSC-3.5 mm (f) or 3.5 mm (m)	DC to 26.5	53 (21)	≥16 dB	0.31 √f +0.2 (1.8B dB at f _{max})	<0.12 dB	0.13 (f) +0.5
85135D semi-rigid cable set	2.4 mm ³ to 7mm	DC to 18	53 (21)	≥17 dB	0.31 √f +0.2 (1.5 dB at f _{max})	<0.06 dB	0.18 (f)
85135F flexible cable set	2.4 mm ³ to 7 mm	DC to 18	62.9 (24.75)	≥17 dB	0.31 √f +0.2 (1.5 dB at f _{max})	<0.12 dB	0.13 (f) +0.5
Single cable for PNA (1.85 mm)							
N4697E flexible cable	1.85 mm ³ to 1.85 mm (f)	DC to 67	96.5 (38)	≥15 dB	1.9 dB/ft at 65 GHz	<0.1 dB	<0.5° (f) + 0.09°
Cable set for PNA (1.85 mm)							
N4697F flexible cable	1.85 mm ³ to 1.85 mm (f)	DC to 67	72 (28)	≥ 15 dB	1.9 dB/ft at 65 GHz	<0.06 dB	<0.5° (f) + 0.04°

1. Phase stability of semi-rigid/flexible cables is specified with a 90-degree bend and a 4"/3" radius.

2. Cable length and stability are supplemental characteristics.

3. Special rugged female connector specifically for connecting to the network analyzer test port. Does not mate with a standard male connector.



Agilent Email Updates

www.agilent.com/find/emailupdates

Get the latest information on the products and applications you select.



Agilent Direct

www.agilent.com/find/agilentdirect

Quickly choose and use your test equipment solutions with confidence.



www.agilent.com/find/open

Agilent Open simplifies the process of connecting and programming test systems to help engineers design, validate and manufacture electronic products. Agilent offers open connectivity for a broad range of system-ready instruments, open industry software, PC-standard I/O and global support, which are combined to more easily integrate test system development.

Remove all doubt

Our repair and calibration services will get your equipment back to you, performing like new, when promised. You will get full value out of your Agilent equipment throughout its lifetime. Your equipment will be serviced by Agilent-trained technicians using the latest factory calibration procedures, automated repair diagnostics and genuine parts. You will always have the utmost confidence in your measurements.

Agilent offers a wide range of additional expert test and measurement services for your equipment, including initial start-up assistance, onsite education and training, as well as design, system integration, and project management.

For more information on repair and calibration services, go to:

www.agilent.com/find/removealldoubt

www.agilent.com

For more information on Agilent Technologies' products, applications or services, please contact your local Agilent office. The complete list is available at:

www.agilent.com/find/contactus

Americas

Canada	(877) 894-4414
Latin America	305 269 7500
United States	(800) 829-4444

Asia Pacific

Australia	1 800 629 485
China	800 810 0189
Hong Kong	800 938 693
India	1 800 112 929
Japan	0120 (421) 345
Korea	080 769 0800
Malaysia	1 800 888 848
Singapore	1 800 375 8100
Taiwan	0800 047 866
Thailand	1 800 226 008

Europe & Middle East

Austria	01 36027 71571
Belgium	32 (0) 2 404 93 40
Denmark	45 70 13 15 15
Finland	358 (0) 10 855 2100
France	0825 010 700*
	*0.125 €/minute
Germany	07031 464 6333
Ireland	1890 924 204
Israel	972-3-9288-504/544
Italy	39 02 92 60 8484
Netherlands	31 (0) 20 547 2111
Spain	34 (91) 631 3300
Sweden	0200-88 22 55
Switzerland	0800 80 53 53
United Kingdom	44 (0) 118 9276201

Other European Countries:

www.agilent.com/find/contactus

Revised: October 6, 2008

Product specifications and descriptions in this document subject to change without notice.

© Agilent Technologies, Inc. 2008, 2009

Printed in USA, February 3, 2009
5988-7988EN

Microsoft®, Windows® and MS-DOS® are U.S. registered trademarks of Microsoft Corporation.

Intel® and Pentium® are US registered trademarks of Intel Corporation.

