

Operating and
Service Manual

Keysight
85133E/F/H
NMD-2.4 mm -f- to 2.4 mm and
Flexible Test Port Return Cables

Notices

© Keysight Technologies, Inc.
1990-2016

No part of this manual may be reproduced in any form or by any means (including electronic storage and retrieval or translation into a foreign language) without prior agreement and written consent from Keysight Technologies, Inc. as governed by United States and international copyright laws.

Trademark Acknowledgments

Manual Part Number

85133-90017

Edition

Edition 1, September 2016

Supersedes: February 2015

Printed in USA/Malaysia

Published by:
Keysight Technologies
1400 Fountaingrove Parkway
Santa Rosa, CA 95403

Warranty

THE MATERIAL CONTAINED IN THIS DOCUMENT IS PROVIDED "AS IS," AND IS SUBJECT TO BEING CHANGED, WITHOUT NOTICE, IN FUTURE EDITIONS. FURTHER, TO THE MAXIMUM EXTENT PERMITTED BY APPLICABLE LAW, KEYSIGHT DISCLAIMS ALL WARRANTIES, EITHER EXPRESS OR IMPLIED WITH REGARD TO THIS MANUAL AND ANY INFORMATION CONTAINED HEREIN, INCLUDING BUT NOT LIMITED TO THE IMPLIED WARRANTIES OF MERCHANTABILITY AND FITNESS FOR A PARTICULAR PURPOSE. KEYSIGHT SHALL NOT BE LIABLE FOR ERRORS OR FOR INCIDENTAL OR CONSEQUENTIAL DAMAGES IN CONNECTION WITH THE FURNISHING, USE, OR PERFORMANCE OF THIS DOCUMENT OR ANY INFORMATION CONTAINED HEREIN. SHOULD KEYSIGHT AND THE USER HAVE A SEPARATE WRITTEN AGREEMENT WITH WARRANTY TERMS

COVERING THE MATERIAL IN THIS DOCUMENT THAT CONFLICT WITH THESE TERMS, THE WARRANTY TERMS IN THE SEPARATE AGREEMENT WILL CONTROL.

Technology Licenses

The hardware and/or software described in this document are furnished under a license and may be used or copied only in accordance with the terms of such license.

U.S. Government Rights

The Software is "commercial computer software," as defined by Federal Acquisition Regulation ("FAR") 2.101. Pursuant to FAR 12.212 and 27.405-3 and Department of Defense FAR Supplement ("DFARS") 227.7202, the U.S. government acquires commercial computer software under the same terms by which the software is customarily provided to the public.

Accordingly, Keysight provides the Software to U.S. government customers under its standard commercial license, which is embodied in its End User License Agreement (EULA), a copy of which can be found at

<http://www.keysight.com/find/sweula>

The license set forth in the EULA represents the exclusive authority by which the U.S. government may use, modify, distribute, or disclose the Software. The EULA and the license set forth therein, does not require or permit, among other things, that Keysight: (1) Furnish technical information related to commercial computer software or commercial computer software documentation that is not customarily provided to the public; or (2) Relinquish to, or otherwise provide, the government rights in excess of these rights customarily provided to the public to use, modify, reproduce, release, perform, display, or disclose commercial computer software or commercial computer software

documentation. No additional government requirements beyond those set forth in the EULA shall apply, except to the extent that those terms, rights, or licenses are explicitly required from all providers of commercial computer software pursuant to the FAR and the DFARS and are set forth specifically in writing elsewhere in the EULA. Keysight shall be under no obligation to update, revise or otherwise modify the Software. With respect to any technical data as defined by FAR 2.101, pursuant to FAR 12.211 and 27.404.2 and DFARS 227.7102, the U.S. government acquires no greater than Limited Rights as defined in FAR 27.401 or DFAR 227.7103-5 (c), as applicable in any technical data.

Safety Notices

CAUTION

A **CAUTION** notice denotes a hazard. It calls attention to an operating procedure, practice, or the like that, if not correctly performed or adhered to, could result in damage to the product or loss of important data. Do not proceed beyond a CAUTION notice until the indicated conditions are fully understood and met.

WARNING

A **WARNING** notice denotes a hazard. It calls attention to an operating procedure, practice, or the like that, if not correctly performed or adhered to, could result in personal injury or death. Do not proceed beyond a WARNING notice until the indicated conditions are fully understood and met.

Table of Contents

1. General Information

The Cable Sets 1-1
 85133E 1-1
 85133F 1-1
 85133H 1-2
 Connector Designators 1-2
 Clarifying the Terminology of a Connector Interface 1-3
 Incoming Inspection 1-3
 Preventive Maintenance 1-4
 Replaceable Parts. 1-4
 Printing Copies of Documentation from the Web 1-4

2. Specifications

Environmental Requirements 2-1
 Electrical Specifications 2-1
 Supplemental Characteristics 2-2
 Center Conductor Pin Depth 2-2

3. Use, Maintenance, and Care of the Cables

Electrostatic Discharge. 3-1
 Visual Inspection. 3-2
 Look for Obvious Defects and Damage First. 3-2
 Inspect the Mating Plane Surfaces 3-3
 Precision Slotless Connectors (2.4 mm) 3-3
 Cleaning Connectors 3-4
 Gaging Connectors. 3-5
 Connector Gage Accuracy 3-5
 When to Gage Connectors 3-6
 Gaging Procedures. 3-6
 Making Connections. 3-9
 How to Make a Connection 3-9
 How to Separate a Connection 3-11
 Handling and Storage 3-11
 Avoiding Cable Movement. 3-12

4. Replaceable Parts

Ordering Replaceable Parts 4-1
 Ordering One Cable in a Cable Set 4-1

Contents

Returning a Cable or Cable Set to Keysight	4-1
Contacting Keysight	4-1
Information About Network Analyzers	4-2
A: Connector Care Quick Reference	
Principles of Microwave Connector Care	A-1

1 General Information

CAUTION

The cable center conductor is fragile and will be seriously damaged if the cable is stretched, bent too tightly, or bent too often. Cables break when the bend radius is too small—less than 2.5" (6 cm) for 1.85 mm cables, and less than 4" (10 cm) for 2.4 mm cables.

Use the following guidelines with cables:

- Never coil the cable too tightly.
 - Never allow the cable to hang down from an instrument test port, or a storage fixture, or while holding it.
 - Never bend the cable an excessive number of times.
-

The Cable Sets

The Keysight 85133E/F/H flexible cable sets are designed for use with Keysight network analyzers that have male NMD-2.4 mm test ports.

85133E

The 85133E set contains a single cable. Use it when a DUT is connected, with the appropriate adapter, directly to the test set test port. See [Figure 1-1](#).

85133F

The 85133F set contains two cables. Each is shorter than the 85133E cable. Use the 85133F cables when a DUT is connected between cable ends. See [Figure 1-1](#).

Figure 1-1 Cable Configurations

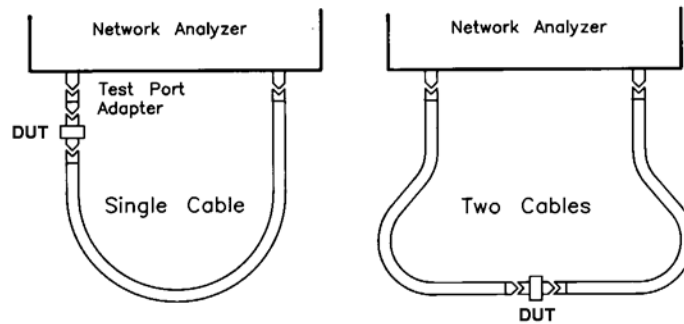

85133H

The 85133H set contains a single cable – the -f- to -m- cable from the 85133F cable set. It is shorter than the 85133E single cable. See [Figure 1-1](#).

Connector Designators

NMD Connectors

NMD denotes a connector that has larger than standard coupling threads for greater stability. NMD connectors are used on test cables, test ports, test port adapters, and test port cables.

Female slotted NMD test port connectors are used on the test set end of adapters and cables, and **cannot** be connected to standard male connectors.

Male NMD connectors are used on test sets (as test ports), and on the DUT end of adapters and cables. Male connectors have both the larger threads (for use with test port adapters) and standard threads (for direct coupling to a DUT).

PSC Connectors

PSC denotes a precision slotless connector. Precision slotless connectors are metrology grade connectors that have better electrical performance, better repeatability, and are more durable than slotted connectors.

Clarifying the Terminology of a Connector Interface

In this document and in the prompts of the PNA calibration wizard, the gender of cable connectors and adapters is referred to in terms of the center conductor. For example, a connector or device designated as 1.85 mm –f– has a 1.85 mm female center conductor.

8510-series, 872x, and 875x ONLY: In contrast, during a measurement calibration, the network analyzer softkey menus label a 1.85 mm calibration device with reference to the sex of the analyzer's test port connector—not the calibration device connector. For example, the label **SHORT (F)** refers to the short that is to be connected to the female test port. This will be a male short from the calibration kit.

Table 1-1 Clarifying the Sex of Connectors: Examples

Terminology	Meaning
Short –f–	Female short (female center conductor)
Short (f)	Male short (male center conductor) to be connected to female port

A connector gage is referred to in terms of the connector that it measures. For instance, a male connector gage has a female connector on the gage so that it can measure male devices.

Incoming Inspection

Verify that the shipment is complete by referring to [Table 4-1 on page 3](#).

If the case or any device appears damaged, or if the shipment is incomplete, notify Keysight. See [“Contacting Keysight” on page 1](#). Keysight will arrange for repair or replacement of incomplete or damaged shipments without waiting for a settlement from the transportation company.

When you send the cable set to Keysight, include the following information:

- your company name and address
- the name of a technical contact person within your company, and the person's complete phone number
- the model number and serial number of the cable set
- the part number and serial number of the device
- the type of service required
- a **detailed** description of the problem

Preventive Maintenance

The best techniques for maintaining the integrity of the cables include:

- routine visual inspection
- cleaning
- proper gaging
- proper connection techniques
- proper storage

All of the above are described in **Chapter 3**. Failure to detect and remove dirt or metallic particles on a mating plane surface can degrade repeatability and accuracy and can damage any connector mated to it. Improper connections, resulting from center conductor values being out of limits (see **Table 2-5 on page 3**), or from bad connections, can also damage cable connectors.

Replaceable Parts

See **Table 4-1 on page 3** for a complete list of cable set contents and their associated part numbers (you can order a single cable rather than the entire cable set), and for recommended items not included with the cable set. Refer to **“Contacting Keysight” on page 1** for information about communicating with Keysight.

Printing Copies of Documentation from the Web

To print copies of documentation from the Web, download the PDF file from the Keysight web site:

- Go to <http://www.keysight.com>.
- Enter the document’s part number (located on the title page) in the Search box.
- Click Search.
- Click on the hyperlink for the document.
- Click the printer icon located in the tool bar.

2 Specifications

Environmental Requirements

Table 2-1 Environmental Requirements

Parameter	Limits
Operating temperature	+20 °C to +26 °C (+68 °F to +79 °F)
Storage temperature	-40 °C to +75 °C (-40 °F to +167 °F)
Altitude	
Operation	< 4,500 meters (≈15,000 feet)
Storage	< 4,500 meters (≈15,000 feet)
Relative humidity	Always non-condensing
Operation	Up to 80% at 30°C
Storage	Up to 95% at 40°C

Electrical Specifications

Table 2-2 Electrical Specifications

Cable	SWR	Return Loss (dB)	Insertion Loss (dB) ^a	Frequency Range (GHz)
85133E	≤1.44	≥15	≤0.446 + 0.017F + 0.456√F	DC to 50
85133F			≤0.450 + 0.013F + 0.300√F	
85133H				

a. F = frequency in GHz.

Supplemental Characteristics

Table 2-3 lists supplemental performance characteristics. These are not specifications, but are intended to provide additional information useful to your application. Supplemental characteristics are typical (but not warranted) performance parameters.

Table 2-3 Supplemental Characteristics (1 of 3)

Cable	Cable Length		Approximate Electrical Length		Magnitude and Phase Stability With a 90° Bend ^{a,b}	Random Use Magnitude and Phase Stability ^{a,c}	Minimum Recommended Bend Radius	
	cm	in	m	ft			cm	in
85133E	97.2	38.25	1.125	3.690	<0.15 dB Change <0.17° (f) + 0.5°	<0.07 dB Change <0.09° (f) + 0.5°	6.352	2.5
85133F	62.9	24.75	0.7376	2.418	<0.08 dB Change <0.08° (f) + 0.5°	<0.04 dB Change <0.04° (f) + 0.5°		
85133H								

- a. (f) = frequency in GHz.
- b. With a 90°, 2.5-inch bend radius.
- c. After three 90°, 2.5-inch bend radius/straighten cycles.

Table 2-4 Supplemental Characteristics (2 of 3)

Cable Set	Number of Cables	Test Set End Connector Type	DUT End Connector Type
85133E	1	NMD-2.4 mm -f- Slotted	PSC-2.4 mm -f- Slotless
85133F	2	NMD-2.4 mm -f- Slotted	NMD-2.4 mm -m- and PSC-2.4 mm -f- Slotless
85133H	1	NMD-2.4 mm -f- Slotted	NMD-2.4 mm -m-

Center Conductor Pin Depth

Center conductor pin depth is the distance the center conductor mating plane differs from being flush with the outer conductor mating plane. See **Figure 2-1**. The pin depth of a center conductor can be in one of two states: either protruding or recessed.

Protrusion is the condition in which the center conductor extends beyond the outer conductor mating plane. This condition will indicate a positive value on the connector gage.

Recession is the condition in which the center conductor is set back from the outer conductor mating plane. This condition will indicate a negative value on the connector gage.

Figure 2-1 Connector Center-Conductor Pin Depth

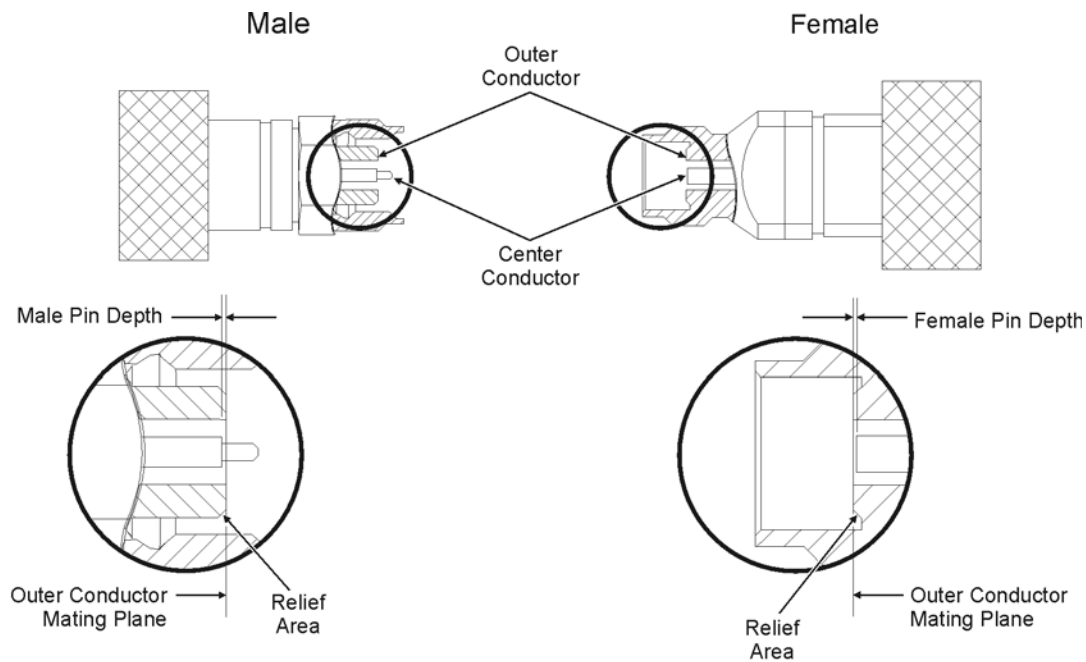

conn185_new

Table 2-5 Supplemental Characteristics (3 of 3)

Center-Conductor Pin Depth				
Precision Connector	Allowable Recession ^a		Allowable Protrusion	
	mm	in	mm	in
NMD-2.4 mm -f-	-0.000 to -0.056	-0.0000 to -0.0022	0.0000	0.0000
NMD-2.4 mm -m-	-0.0025 to -0.0254	-0.0001 to -0.001		
PSC-2.4 mm -f-	-0.0025 to -0.0254	-0.0001 to -0.001		

a. Center conductor shoulder behind outer conductor mating plane.

Specifications
Supplemental Characteristics

3 Use, Maintenance, and Care of the Cables

Electrostatic Discharge

Protection against ESD (electrostatic discharge) is essential while connecting, inspecting, or cleaning connectors attached to a static-sensitive circuit (such as those found in test sets).

Static electricity can build up on your body and can easily damage sensitive internal circuit elements when discharged. Static discharges too small to be felt can cause permanent damage. Devices such as calibration components and devices under test (DUTs), can also carry an electrostatic charge. To prevent damage to the test set, components, and devices:

- **always** wear a grounded wrist strap having a 1 M Ω resistor in series with it when handling components and devices or when making connections to the test set.
- **always** use a grounded, conductive table mat while making connections.
- **always** wear a heel strap when working in an area with a conductive floor. If you are uncertain about the conductivity of your floor, wear a heel strap.
- **always** ground yourself before you clean, inspect, or make a connection to a static-sensitive device or test port. You can, for example, grasp the grounded outer shell of the test port or cable connector briefly.
- **always** ground the center conductor of a test cable before making a connection to the analyzer test port or other static-sensitive device. This can be done as follows:
 1. Connect a short (from your calibration kit) to one end of the cable to short the center conductor to the outer conductor.
 2. While wearing a grounded wrist strap, grasp the outer shell of the cable connector.
 3. Connect the other end of the cable to the test port.
 4. Remove the short from the cable.

Refer to **Chapter 4** for part numbers and instructions for ordering ESD protection devices.

Figure 3-1 ESD Protection Setup

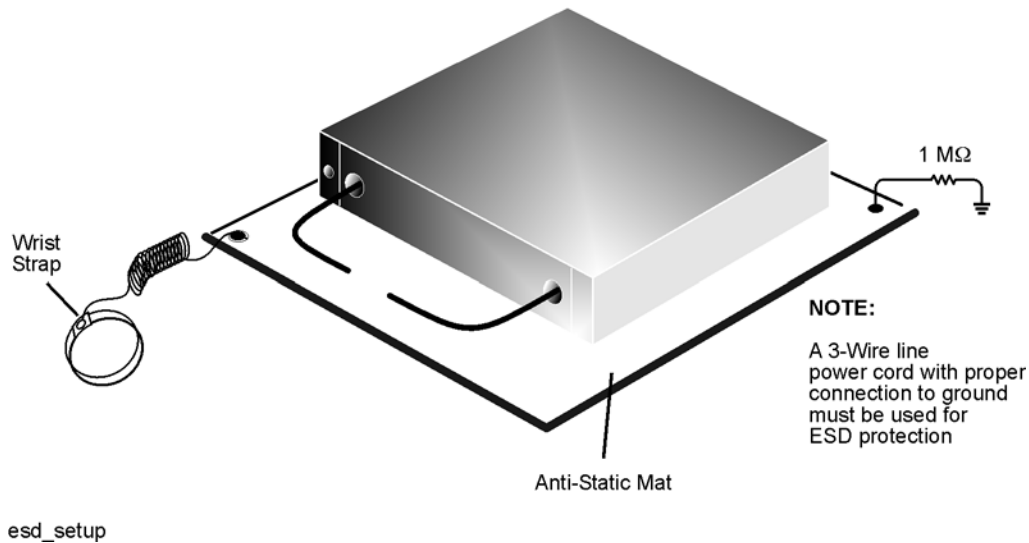

Visual Inspection

Visual inspection and, if necessary, cleaning should be done every time a connection is made. Metal particles from the connector threads may fall onto the mating plane surface of the connector when it is disconnected. One connection made with a dirty or damaged connector can damage both connectors beyond repair.

Magnification is helpful when inspecting connectors, but it is not required and may actually be misleading. Defects and damage that cannot be seen without magnification generally have no effect on electrical or mechanical performance. Magnification is of great use in analyzing the nature and cause of the damage and in cleaning connectors, but it is not required for inspection. Use the following guidelines when evaluating the integrity of a connector.

Look for Obvious Defects and Damage First

Examine the connector first for obvious defects and damage: badly worn plating on the connector interface, deformed threads, or bent, broken, or misaligned center conductors. Connector nuts should move smoothly and be free of burrs, loose metal particles, and rough spots.

What Causes Connector Wear?

Connector wear is caused by connecting and disconnecting the cable. The more use a connector gets, the faster it wears and degrades. The wear is greatly accelerated when connectors are not kept clean, or are connected incorrectly.

Connector wear eventually degrades performance of the cable. Replace cables with worn connectors.

The test port connectors on the network analyzer test set may have many connections each day, and are therefore also subject to wear. It is recommended that an adapter be used as a test port saver to minimize the wear on the test set's test port connectors.

Inspect the Mating Plane Surfaces

Flat contact between the connectors at all points on their mating plane surfaces is required for a good connection. Look especially for deep scratches or dents, and for dirt and metal particles on the connector mating plane surfaces. Also look for signs of damage due to excessive or uneven wear or misalignment.

Light burnishing of the mating plane surfaces is normal, and is evident as light scratches or shallow circular marks distributed more or less uniformly over the mating plane surface. Other small defects and cosmetic imperfections are also normal. None of these affect electrical or mechanical performance.

If a connector shows deep scratches or dents, particles clinging to the mating plane surfaces, or uneven wear, clean and inspect it again. Cables with damaged connectors should be repaired or discarded. Determine the cause of damage before connecting a new, undamaged connector in the same configuration.

Precision Slotless Connectors (2.4 mm)

The female 2.4 mm connectors in the cable sets are metrology-grade, precision slotless connectors (PSC). Precision slotless connectors are used to improve accuracy. A characteristic of metrology-grade connectors is directly traceability to national measurement standards through their well-defined mechanical dimensions. With PSCs on test ports and standards, the accuracy achieved when measuring at 50 dB return loss levels is comparable to using conventional slotted connectors measuring devices having only 30 dB return loss. This represents an accuracy improvement of about 10 times.

Conventional female center conductors are slotted and, when mated, are flared by the male pin. Because physical dimensions determine connector impedance, this change in physical dimension affects electrical performance, making it very difficult to perform precision measurements with conventional slotted connectors.

The precision slotless connector was developed to eliminate this problem. The PSC has a center conductor with a solid cylindrical shell, the outside diameter of which does not change when mated. Instead, the center conductor has an internal contact that flexes to accept the male pin.

Cleaning Connectors

Clean connectors are essential for ensuring the integrity of RF and microwave coaxial connections.

1. Use Compressed Air or Nitrogens

WARNING

Always use protective eyewear when using compressed air or nitrogen.

Use compressed air (or nitrogen) to loosen particles on the connector mating plane surfaces.

You can use any source of clean, dry, low-pressure compressed air or nitrogen that has an effective oil-vapor filter and liquid condensation trap placed just before the outlet hose.

Ground the hose nozzle to prevent electrostatic discharge, and set the air pressure to less than 414 kPa (60 psi) to control the velocity of the air stream. High-velocity streams of compressed air can cause electrostatic effects when directed into a connector. These electrostatic effects can damage the device. Refer to **“Electrostatic Discharge”** earlier in this chapter for additional information.

2. Clean the Connector Threads

WARNING

Keep isopropyl alcohol away from heat, sparks, and flame. Store in a tightly closed container. It is extremely flammable. In case of fire, use alcohol foam, dry chemical, or carbon dioxide; water may be ineffective.

Use isopropyl alcohol with adequate ventilation and avoid contact with eyes, skin, and clothing. It causes skin irritation, may cause eye damage, and is harmful if swallowed or inhaled. It may be harmful if absorbed through the skin. Wash thoroughly after handling.

In case of spill, soak up with sand or earth. Flush spill area with water.

Dispose of isopropyl alcohol in accordance with all applicable federal, state, and local environmental regulations.

Use a lint-free swab or cleaning cloth moistened with isopropyl alcohol to remove any dirt or stubborn contaminants on a connector that cannot be removed with compressed air or nitrogen. Refer to **Table 4-1 on page 3** for part numbers for isopropyl alcohol and cleaning swabs.

- a. Apply a small amount of isopropyl alcohol to a lint-free cleaning swab.
- b. Clean the connector threads.

- c. Let the alcohol evaporate, then blow the threads dry with a gentle stream of clean, low-pressure compressed air or nitrogen. Always completely dry a connector before you reassemble or use it.

3. Clean the Mating Plane Surfaces

- a. Apply a small amount of isopropyl alcohol to a lint-free cleaning swab.
- b. Clean the center and outer conductor mating plane surfaces. Refer to [Figure 2-1 on page 3](#). When cleaning a female connector, avoid snagging the swab on the center conductor contact fingers by using short strokes.
- c. Let the alcohol evaporate, then blow the connector dry with a gentle stream of clean, low-pressure compressed air or nitrogen. Always completely dry a connector before you reassemble or use it.

4. Reinspect

Inspect the connector again to make sure that no particles or residue are present.

Gaging Connectors

The gages available from Keysight Technologies are intended for preventive maintenance and troubleshooting purposes only. (See [Table 4-1 on page 3](#) for part number information.) They are effective in detecting excessive center conductor protrusion or recession, and conductor damage on test cables and other accessories, DUTs, and calibration kit devices. **Do not use the gages for precise pin depth measurements.**

Connector Gage Accuracy

The connector gages are only capable of performing coarse measurements. They do not provide the degree of accuracy necessary to precisely measure the pin depth of the cable connectors. This is partially due to the repeatability uncertainties that are associated with the measurement. Only the factory—through special gaging processes and electrical testing— can accurately verify the mechanical characteristics of the cable connectors.

With proper technique, however, the gages are useful in detecting gross pin depth errors on cable connectors. To achieve maximum accuracy, random errors must be reduced by taking the average of at least three measurements having different gage orientations on the connector. Even the resultant average can be in error by as much as ± 0.0001 inch due to systematic (biasing) errors usually resulting from worn gages and gage masters. The

information in Table 2-3 on page 2-4 assumes new gages and gage masters. As your gages undergo more use, their systematic errors can become more significant in the accuracy of the measurement.

NOTE

When measuring pin depth, the measured value (resultant average of three or more measurements) contains measurement uncertainty and is not necessarily the true value. Always compare the measured value with the observed pin depth limits (which account for measurement uncertainties) in [Table 2-5 on page 3](#) to evaluate the condition of cable connectors.

When to Gage Connectors

Gage a connector at the following times:

- Prior to using a cable for the first time: record the pin depth measurement so that it can be compared with future readings. (It will serve as a good troubleshooting tool when you suspect damage may have occurred to the cable connector.)
- If either visual inspection or electrical performance suggests that the connector interface may be out of typical range (due to wear or damage, for example).
- If a cable is used by someone else or on another system or piece of equipment.
- Initially after every 100 connections, and after that as often as experience indicates.

Gaging Procedures

Gaging 2.4 mm Connectors

NOTE

Always hold a connector gage by the gage barrel, below the dial indicator. This gives the best stability, and improves measurement accuracy. (Cradling the gage in your hand or holding it by the dial applies stress to the gage plunger mechanism through the dial indicator housing.)

1. Select the proper gage for your connector. Refer to [Table 4-1 on page 3](#) for gage part numbers.
2. Inspect and clean the gage, gage master, and device to be gaged. Refer to [“Visual Inspection”](#) and [“Cleaning Connectors”](#) earlier in this chapter.
3. Zero the connector gage (refer to [Figure 3-2](#)):
 - a. While holding the gage by the barrel, and without turning the gage or the device, connect the gage to the gage master by interconnecting the male and female connectors. Connect the nut finger tight. Do not overtighten.

- b. Using an open-end wrench to keep the device body from rotating, use the torque wrench recommended for use to tighten the connecting nut to the specified torque. Refer to “**Final Connection Using a Torque Wrench**” on page 10 for additional information.
- c. As you watch the gage pointer, gently tap the barrel of the gage to settle the reading.

The gage pointer should line up exactly with the zero mark on the gage. If not, adjust the zero set knob until the gage pointer lines up exactly with the zero mark.

- d. Remove the gage master.

4. Gage the device connector (refer to **Figure 3-2**):

- a. While holding the gage by the barrel, and without turning the gage or the device, connect the gage to the device by interconnecting the male and female connectors. Connect the nut finger-tight. Do not overtighten.
- b. Using an open-end wrench to keep the device body from rotating, use the torque wrench included in the kit to tighten the connecting nut to the specified torque. Refer to “**Final Connection Using a Torque Wrench**” on page 10 for additional information.
- c. Gently tap the barrel of the gage with your finger to settle the gage reading.
- d. Read the gage indicator dial. Read **only** the black \pm signs; **not** the red \pm signs.

For maximum accuracy, measure the connector a minimum of three times and take an average of the readings. After each measurement, rotate the gage a quarter-turn to reduce measurement variations that result from the gage or the connector face not being exactly perpendicular to the center axis.

- e. Compare the average reading with the observed pin depth limits in Table 2-3 on page 2-4.

Figure 3-2 Gaging 2.4 mm Connectors

Note:

Although male devices are shown in this illustration, the procedure is essentially the same for female devices.

Zero the Connector Gage

- Connect the gage to the gage master.
- Torque the connecting nut.
- Gently tap the gage barrel to settle the reading.
- Using the zero set knob, adjust the gage pointer to line up exactly with the zero mark.
- Remove the gage master.

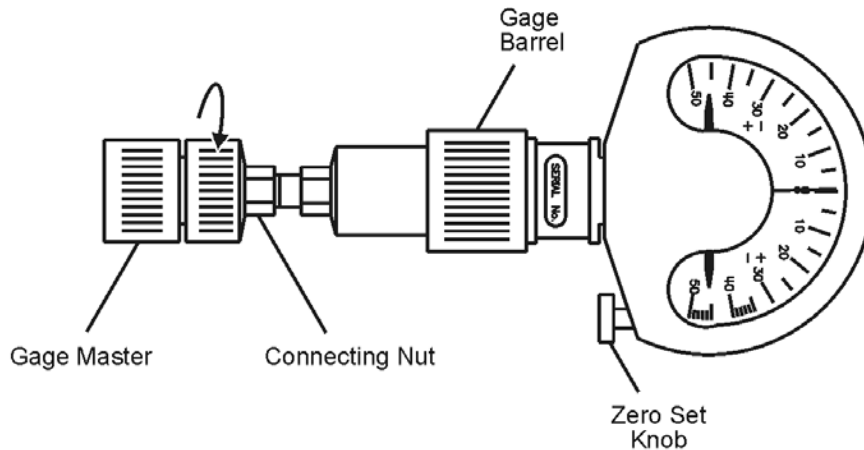

Gage the Device Connector

- Connect the gage to the device being measured.
- Torque the connecting nut.
- Gently tap the gage barrel to settle the reading.
- Read recession or protrusion from the gage.
- Remove the device.
- Repeat two additional times and average the three readings.

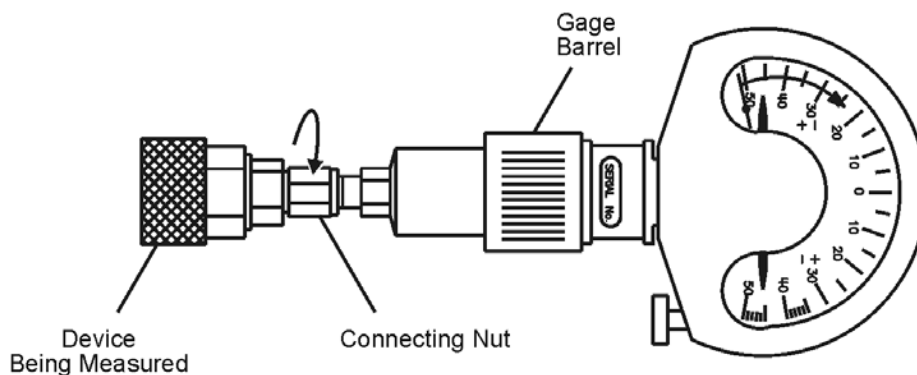

ph71a

Making Connections

Good connections require a skilled operator. **The most common cause of measurement error is bad connections.** The following procedures illustrate how to make good connections.

How to Make a Connection

Preliminary Connection

1. Ground yourself and all devices. Wear a grounded wrist strap and work on a grounded, conductive table mat. Refer to **“Electrostatic Discharge” on page 1** for ESD precautions.
2. Visually inspect the connectors. Refer to **“Visual Inspection” on page 2**.
3. If necessary, clean the connectors. Refer to **“Cleaning Connectors” on page 4**.
4. Use a connector gage to verify that all center conductors are within the observed pin depth values in Table 2-3 on page 2-4. Refer to **“Gaging Connectors” on page 5**.
5. Carefully align the connectors. The male connector center pin must slip concentrically into the contact finger of the female connector.
6. Push the connectors straight together and tighten the connector nut finger-tight.

CAUTION

Do **not** turn the device body. Only turn the connector nut. Damage to the center conductor can occur if the device body is twisted.

Do **not** twist or screw the connectors together. As the center conductors mate, there is usually a slight resistance.

7. The preliminary connection is tight enough when the mating plane surfaces make uniform, light contact. Do not overtighten this connection.

A connection in which the outer conductors make gentle contact at all points on both mating surfaces is sufficient. Very light finger pressure is enough to accomplish this.

8. Make sure the connectors are properly supported. Relieve any side pressure on the connection from long or heavy devices or cables.

Final Connection Using a Torque Wrench

Use a torque wrench to make a final connection. [Table 3-1](#) provides information about the torque wrench recommended for use with the calibration kit. Refer to [Table 4-1 on page 3](#) for replacement part number and ordering information.

Table 3-1 Torque Wrench Information

Connector Type	Torque Setting	Torque Tolerance
2.4 mm	90 N-cm (8 in-lb)	± 9.0 N-cm (± 0.8 in-lb)

Using a torque wrench guarantees that the connection is not too tight, preventing possible connector damage. It also guarantees that all connections are equally tight each time.

Prevent the rotation of anything other than the connector nut that you are tightening. It may be possible to do this by hand if one of the connectors is fixed (as on a test port). However, it is recommended that you use an open-end wrench to keep the body of the device from turning.

1. Position both wrenches within 90 degrees of each other before applying force. See [Figure 3-3](#). Wrenches opposing each other (greater than 90 degrees apart) will cause a lifting action which can misalign and stress the connections of the devices involved. This is especially true when several devices are connected together.

Figure 3-3 Wrench Positions

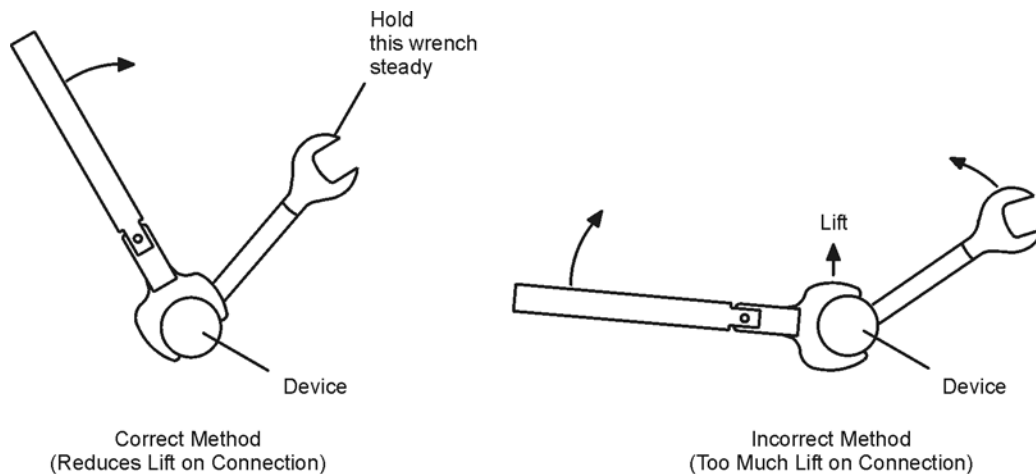

nh711a

2. Hold the torque wrench lightly, at the end of the handle only (beyond the groove). See [Figure 3-4](#).

Figure 3-4 Using the Torque Wrench

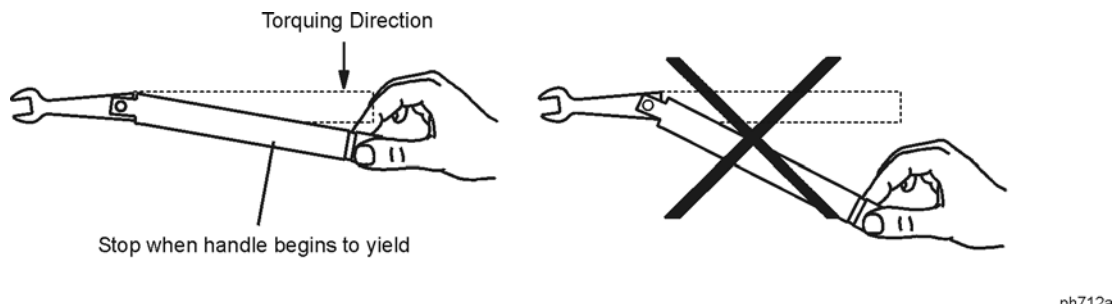

3. Apply downward force perpendicular to the wrench handle. This applies torque to the connection through the wrench.

Do not hold the wrench so tightly that you push the handle straight down along its length rather than pivoting it, otherwise you apply an unknown amount of torque.

4. Tighten the connection just to the torque wrench break point. The wrench handle gives way at its internal pivot point. See [Figure 3-4](#). Do not tighten the connection further.

CAUTION

You don't have to fully break the handle of the torque wrench to reach the specified torque; doing so can cause the handle to kick back and loosen the connection. Any give at all in the handle is sufficient torque.

How to Separate a Connection

To avoid lateral (bending) force on the connector mating plane surfaces, always support the devices and connections.

CAUTION

Do not turn the device body. Only turn the connector nut. Damage to the center conductor can occur if the device body is twisted.

1. Use an open-end wrench to prevent the device body from turning.
2. Use the torque wrench to loosen the connecting nut.
3. Complete the separation by hand, turning only the connecting nut.
4. Pull the connectors straight apart without twisting, rocking, or bending either of the connectors.

Handling and Storage

- Install the protective end caps and store the cables in the foam-lined storage case when not in use.

Use, Maintenance, and Care of the Cables Handling and Storage

- Never store cables loose in a box, desk, or bench drawer. This is the most common cause of cable connector damage during storage.
- Store cables in the same shape they have when you use them; do not either straighten a cable or flex it more tightly. Even flexible cables last longer if you flex them as little as possible.
- Keep cable connectors clean.
- Do not touch connector mating plane surfaces. Natural skin oils and microscopic particles of dirt are easily transferred to a connector interface and are very difficult to remove.
- Do not set cable connectors contact-end down on a hard surface. The plating and the mating plane surfaces can be damaged if the interface comes in contact with any hard surface.

Avoiding Cable Movement

When you use cables to make a precise calibration, you may have to fixture the cables to prevent excessive movement after the calibration. In some cases, unless you restrict cable movement, you may not be able to perform a verification after the calibration, especially if you use a precision calibration kit.

NOTE

After you perform a calibration, move the cables as little as possible. Every time you bend a cable, the phase changes slightly.

4 Replaceable Parts

Ordering Replaceable Parts

Table 4-1 on page 3 lists the replacement part numbers for items included in the 85133E/F/H cable sets.

To order a listed part, note the description, the part number, and the quantity desired. Telephone or send your order to Keysight Technologies (see **“Contacting Keysight” on page 1**).

Ordering One Cable in a Cable Set

If you need only one of the cables in a cable set and don't want to order an entire set, use the appropriate **single** cable part number listed in **Table 4-1 on page 3**. When you order using a **single** cable part number, you do not get a pair of cables; be sure you order the correct cable part number(s).

Returning a Cable or Cable Set to Keysight

If your cable set requires service, contact Keysight Technologies (see below). Include the following information:

- your company name and address
- a technical contact person within your company, and the person's complete phone number
- the model number and serial number of the cable set
- the part number and serial number of each device
- the type of service required
- a **detailed** description of the problem and how the device was being used when the problem occurred (such as calibration or measurement)

Contacting Keysight

Assistance with test and measurement needs and information on finding a local Keysight office are available on the Web at:

<http://www.keysight.com/find/assist>

Replaceable Parts
Returning a Cable or Cable Set to Keysight

If you do not have access to the Internet, please contact your Keysight field engineer.

NOTE

In any correspondence or telephone conversation, refer to the Keysight product by its model number and full serial number. With this information, the Keysight representative can determine whether your product is still within its warranty period.

Information About Network Analyzers

This document contains limited information about network analyzer system operation. For complete information, refer to the instrument documentation.

Replaceable Parts
Returning a Cable or Cable Set to Keysight

Table 4-1 **Replaceable Parts**

Description ^a	Qty	Keysight Part Number
Cables		
85133E Single Cable:		
NMD-2.4 mm -f- to PSC-2.4 mm -f-	1	85133-60041 Was: 85133-60015
85133F Cables:		
NMD-2.4 mm -f- to NMD-2.4 mm -m-	1	85133-60043 Was: 85133-60017
NMD-2.4 mm -f- to PSC-2.4 mm -f-	1	85133-60042 Was: 85133-60016
85133H Single Cable:		
NMD-2.4 mm -f- to NMD-2.4 mm -m-	1	85133-60043 Was: 85133-60017
Miscellaneous		
Operating and Service Manual	1	85133-90017
Protective End Caps		
STR 0.812-ID black	as necessary	1401-0214
STR 0.234-ID red		1401-0202
Items NOT Included in a Cable Set:		
ESD Protective Devices		
Grounding wrist strap	1	9300-1367
5 ft grounding cord for wrist strap	1	9300-0980
2 ft by 4 ft conductive table mat with 15 ft grounding wire	1	9300-0797
ESD heel strap	1	9300-1308
Connector Cleaning Supplies		
Isopropyl alcohol	30 ml	8500-5344
Foam tipped cleaning swabs	100	9301-1243
Wrenches		
20 mm (8 in-lb) torque wrench	1	8710-1764
5/16 in., 90 N-cm (8 in-lb) torque wrench	1	8710-1765
7 mm open-end wrench	1	8710-1761
Miscellaneous		

Replaceable Parts
Returning a Cable or Cable Set to Keysight

Table 4-1 Replaceable Parts

Description ^a	Qty	Keysight Part Number
2.4 mm female gage set	1	85056-60017
2.4 mm male gage set	1	85056-60018
10x Magnifying Glass	1	1000-1114
2.4 mm 50 Ω fixed termination -m-	1	00901-60001
2.4 mm 50 Ω fixed termination -f-	1	00901-60002
2.4 mm offset short -m-	1	85056-60001
2.4 mm offset short -f-	1	85056-60002
2.4 mm airline (5.0 cm)	1	85057-60001

a. Refer to **“Clarifying the Terminology of a Connector Interface”** on page 3.

A: Connector Care Quick Reference

Principles of Microwave Connector Care

Proper connector care and connection techniques are critical for accurate, repeatable measurements and for extending the life of your devices.

Prior to making connections to the network analyzer, carefully review the connector care information provided with your product.

See the following table for quick reference tips about connector care.

Table 1 Connector Care Quick Reference

Handling and Storage	
Do	Do Not
Keep connectors clean	Touch mating-plane surfaces
Extend sleeve or connector nut	Set connectors contact – end down
Use plastic end-caps during storage	
Visual Inspection	
Do	Do Not
Inspect all connectors carefully	Use a damaged connector – ever
Look for metal particles, scratches, and dents	
Connector Cleaning	
Do	Do Not
Try compressed air first	Use any abrasives
Use isopropyl alcohol ^a	Get liquid into plastic support beads
Clean connector threads	
Gaging Connectors	
Do	Do Not
Clean and zero the gage before use	Use an out-of-spec connector
Use the correct gage type	
Use correct end of calibration block	
Gage all connectors before first use	
Making Connections	
Do	Do Not
Align connectors carefully	Apply bending force to connection
Make preliminary connection lightly	Over tighten preliminary connection
Turn only the connector nut	Twist or screw any connection
Use a torque wrench for final connect	Tighten past torque wrench “break” point

a. Use isopropyl alcohol in a well-ventilated area, allowing adequate time for moist alcohol to evaporate and fumes to disperse prior to energizing equipment.

Index

A

adapters, part numbers 4-3
 Agilent, contacting 4-1
 alcohol, isopropyl, as cleaning solvent 3-4
 altitude 2-1
 avoiding cable movement 3-12

C

cable
 length 2-2
 maintenance 1-4
 movement 3-12
 part numbers 4-3
 cable set
 overview 1-1
 return to Agilent 4-1
 center conductor pin depth 2-2
 characteristics
 supplemental 2-2
 cleaning connectors 3-4
 cleaning supplies
 ordering 4-3
 part numbers 4-3
 communicating with Agilent 4-1
 compressed air or nitrogen 3-4
 conductor
 mating plane 2-2
 connections 3-1, 3-9
 ESD protection 3-9
 final 3-10
 preliminary 3-9
 separating 3-11
 using torque wrench 3-10
 connector
 care A-1
 cleaning 3-4
 cleaning supplies 4-3
 damage 3-2
 gage
 accuracy 3-5
 handling 3-6
 when to do 3-6
 zeroing 3-6
 gaging 3-6
 life 3-2
 mating plane 3-5
 NMD type 1-2

PSC type 1-2
 quick reference A-2
 sex 1-3
 slotless 3-3
 threads 3-4
 type
 DUT end 2-2
 test set end 2-2
 visual inspection 3-2
 wear 3-2
 connector terminology 1-3
 contacting Agilent 4-1

D

damage
 to connectors 3-2
 to shipment 1-3
 defective connectors 3-2
 description of cable sets 1-1
 device
 conductor
 mating plane 2-2
 connecting 3-9
 disconnecting 3-11
 handling 3-11
 part numbers 4-3
 return to Agilent 4-1
 storage 3-11
 visual inspection 3-2
 dimensions
 device
 outer conductor 2-2
 disconnections 3-11

E

electrical length 2-2
 electrical specifications 2-1
 electrostatic discharge 3-1
 supplies
 part numbers 4-3
 environmental requirements 2-1
 equipment
 supplied 4-1, 4-3
 ESD 3-1
 precautions 3-1, 3-4
 supplies
 part numbers 4-3

F

frequency range
specifications 2-1

G

gage
connector
 handling 3-6
 master 4-3
 zeroing 3-6
gage master
 part numbers 4-3
gaging
 connectors 3-6
 when to do 3-6
gender, connector 1-3

H

handling 3-11
humidity 2-1

I

incoming inspection 1-3
insertion loss
 specifications 2-1
inspection
 damage 3-2
 defects 3-2
 incoming 1-3
 mating plane 3-3
 visual 3-2
isopropyl alcohol, as cleaning solvent 3-4

L

length
 cable 2-2
 electrical 2-2

M

magnitude 2-2
maintenance 3-1
 preventive 1-4
making connections 3-9
 ESD protection 3-9
 precautions 3-9
manual
 part number 4-3
mating plane
 conductor 2-2

connector 3-5
inspection 3-3
surfaces 3-5
movement of cables 3-12

N

nitrogen 3-4
NMD connectors 1-2

O

open-end wrench 3-11
 part number 4-3
ordering parts 4-1

P

parts
 numbers 4-1
 ordering 4-1
 replaceable 4-1
 required but not supplied 4-3
phase stability 2-2
pin depth 2-2
 definition of 2-2
 protrusion 2-2
 recession 2-2
preventive maintenance 1-4
protrusion
 pin depth 2-2
PSC connectors 1-2

Q

quick reference, connector care A-2

R

reaching Agilent 4-1
recession
 pin depth 2-2
regulations
 environmental 3-5
replaceable parts 4-1
requirements
 environmental 2-1
return loss
 specifications 2-1
return, set or cable 4-1

S

separating connections 3-11
set

- overview 1-1
- return to Agilent 4-1
- sex, connector 1-3
- shipment
 - damage 1-3
 - verifying complete 1-3
- specifications 2-1
 - altitude 2-1
 - electrical 2-1
 - environmental 2-1
 - frequency 2-1
 - frequency range 2-1
 - humidity 2-1
 - insertion loss 2-1
 - return loss 2-1
 - temperature 2-1
 - torque wrench 3-10
- stability, phase 2-2
- static discharge 3-1
- storage 3-11
 - altitude 2-1
 - humidity 2-1
 - temperature 2-1
- supplemental characteristics 2-2

T

- temperature
 - operating range 2-1
- threads
 - connector 3-4
- torque wrench
 - part number 4-3
 - specifications 3-10

V

- visual inspection 3-2

W

- wrench
 - open-end 3-10, 3-11, 4-3
 - part numbers 4-3
 - proper positioning of 3-10
 - torque 3-10, 3-11, 4-3
 - precautions for use of 3-11
 - proper use of 3-11

Z

- zeroing
 - connector gage 3-6



This information is subject to change without notice.

© Keysight Technologies 1990-2016

Edition 1, September 2016



85133-90017

www.keysight.com