

Keysight Wireless Test Platform

E7515B UXM 5G Wireless Test Platform

Getting Started
Guide

Notices

© Keysight Technologies, Inc.
2014-2021

No part of this manual may be reproduced in any form or by any means (including electronic storage and retrieval or translation into a foreign language) without prior agreement and written consent from Keysight Technologies, Inc. as governed by United States and international copyright laws.

Trademark Acknowledgments

Manual Part Number

E7515-90040

Edition

Edition 1, October 2021

Supersedes July 2021

Printed in USA/Malaysia

Published by:
Keysight Technologies
1400 Fountaingrove Parkway
Santa Rosa, CA 95403

Warranty

THE MATERIAL CONTAINED IN THIS DOCUMENT IS PROVIDED "AS IS," AND IS SUBJECT TO BEING CHANGED, WITHOUT NOTICE, IN FUTURE EDITIONS. FURTHER, TO THE MAXIMUM EXTENT PERMITTED BY APPLICABLE LAW, KEYSIGHT DISCLAIMS ALL WARRANTIES, EITHER EXPRESS OR IMPLIED WITH REGARD TO THIS MANUAL AND ANY INFORMATION CONTAINED HEREIN, INCLUDING BUT NOT LIMITED TO THE IMPLIED WARRANTIES OF MERCHANTABILITY AND FITNESS FOR A PARTICULAR PURPOSE. KEYSIGHT SHALL NOT BE LIABLE FOR ERRORS OR FOR INCIDENTAL OR CONSEQUENTIAL DAMAGES IN CONNECTION WITH THE FURNISHING, USE, OR PERFORMANCE OF THIS DOCUMENT OR ANY INFORMATION CONTAINED HEREIN. SHOULD KEYSIGHT AND THE USER HAVE A SEPARATE WRITTEN AGREEMENT WITH WARRANTY TERMS

COVERING THE MATERIAL IN THIS DOCUMENT THAT CONFLICT WITH THESE TERMS, THE WARRANTY TERMS IN THE SEPARATE AGREEMENT WILL CONTROL.

Technology Licenses

The hardware and/or software described in this document are furnished under a license and may be used or copied only in accordance with the terms of such license.

U.S. Government Rights

The Software is "commercial computer software," as defined by Federal Acquisition Regulation ("FAR") 2.101. Pursuant to FAR 12.212 and 27.405-3 and Department of Defense FAR Supplement ("DFARS") 227.7202, the U.S. government acquires commercial computer software under the same terms by which the software is customarily provided to the public.

Accordingly, Keysight provides the Software to U.S. government customers under its standard commercial license, which is embodied in its End User License Agreement (EULA), a copy of which can be found at

<http://www.keysight.com/find/sweula>

The license set forth in the EULA represents the exclusive authority by which the U.S. government may use, modify, distribute, or disclose the Software. The EULA and the license set forth therein, does not require or permit, among other things, that Keysight: (1) Furnish technical information related to commercial computer software or commercial computer software documentation that is not customarily provided to the public; or (2) Relinquish to, or otherwise provide, the government rights in excess of these rights customarily provided to the public to use, modify, reproduce, release, perform, display, or disclose commercial computer software or commercial computer software

documentation. No additional government requirements beyond those set forth in the EULA shall apply, except to the extent that those terms, rights, or licenses are explicitly required from all providers of commercial computer software pursuant to the FAR and the DFARS and are set forth specifically in writing elsewhere in the EULA. Keysight shall be under no obligation to update, revise or otherwise modify the Software. With respect to any technical data as defined by FAR 2.101, pursuant to FAR 12.211 and 27.404.2 and DFARS 227.7102, the U.S. government acquires no greater than Limited Rights as defined in FAR 27.401 or DFAR 227.7103-5 (c), as applicable in any technical data.

Safety Notices

CAUTION

A **CAUTION** notice denotes a hazard. It calls attention to an operating procedure, practice, or the like that, if not correctly performed or adhered to, could result in damage to the product or loss of important data. Do not proceed beyond a CAUTION notice until the indicated conditions are fully understood and met.

WARNING

A **WARNING** notice denotes a hazard. It calls attention to an operating procedure, practice, or the like that, if not correctly performed or adhered to, could result in personal injury or death. Do not proceed beyond a WARNING notice until the indicated conditions are fully understood and met.

Where to Find the Latest Information

Documentation is updated periodically. For the latest information about these products, including instrument software upgrades, application information, and product information, browse to one of the following URLs, according to the name of your product:

<http://www.keysight.com/find/e7515B>

To receive the latest updates by email, subscribe to Keysight Email Updates at the following URL:

<http://www.keysight.com/find/MyKeysight>

Information on preventing instrument damage can be found at:

www.keysight.com/find/PreventingInstrumentRepair

Is your product software up-to-date?

Periodically, Keysight releases software updates to fix known defects and incorporate product enhancements. To search for software updates for your product, go to the Keysight Technical Support website at:

<http://www.keysight.com/find/techsupport>

Table of Contents

Safety & Environmental Information 9

- Warning Statements and Symbols 10
- Safety 11
 - Safety Compliance 11
 - Acoustic statement (European Machinery Directive) 11
 - General Safety Notices 11
 - Electrical Safety 12
- Environmental Conditions (Operating) 13
 - Environmental Information 13
- EMC (Electromagnetic Compatibility) 14
 - South Korean Class A EMC declaration 14
 - Declaration of Conformity 14
- Instrument Location and Rack Mounting Requirements 15
 - Locating the Test Platform 15
 - Table Top Ambient Temperature 15
 - Rack Mounting: Hardware and Temperature 15
- Ventilation 16
- Power Requirements 17
 - Older power supply 17
 - AC power safety 18
- Using Accessories 19
- Weight and Dimensions 19
- Lifting 19
- Protecting against electrostatic discharge 20
- Protecting against excessive input power 21
- Instrument Maintenance 22
 - Cleaning the Instrument 22
 - Cleaning the connectors 22

Quick Start 23

- Overview 24
 - Purpose and Function 24
- Initial Inspection 25
 - Shipping Problems? 26
- UXM 5G Applications 27
 - About the test applications 27

Contents

- Installing the test applications 27
- RF Interface 28
- Millimeter-Wave Accessory Instruments 29
- Turning On the Test Platform the First Time 31
 - Shutting Down the Test Platform 36
- Licensing 37
 - Transportable Licenses 38
- LAN Connectivity 39
 - Corporate Domains 39
- Windows Updates 40
- Anti-virus Protection and Firewalls 42
- Reference Documents 43

Control Panel Functions 45

- The Control Panel 46
 - Viewing the Control Panel 46
 - Control Panel Icons 47

Front and Rear Panel Functions 49

- Front Panel Features 50
 - Power Status Indicator 52
- Rear Panel Features 53
 - Slot 0: ICM Connectors 54
 - Slots 1, 3: FPGA Expansion Module (E7515B-FP1) 55
 - Slots 2, 4, 5: VDTAMC Cards 56
 - Slot 7: CCTAMC Card 57
 - Slots 8, 9: DCB+ Connectors 58
 - Slot 10: AUXM Connectors 59
 - Slots 11, 10: RFIO 60
 - PCM 61
 - AC Power 61
- Front and Rear Panel Symbols 62

Test Platform Operating System 65

- Keysight Software Installed 66
 - Customer Installation of Software 66
- User Accounts 67
 - Administrator Account 67
 - Changing Account Passwords 68
- System Maintenance 71

- Back-up 71
- System Restore 71
- Hard Drive Partitioning and Use 72
- Disk Drive Recovery Process 73
- Updating the Keysight E7515B UXM 5G software 77
 - Using the E7515B/E7515B UXM 5G Firmware Update Tool 77
- Updating the Keysight 5G NR Test Application 79
 - Updating the Application 79
- Troubleshooting 83**
 - Identifying Problems 84
 - Returning Your Test Set for Service 85
 - Calling Keysight Technologies 85
 - Locations for Keysight Technologies 86

Contents

1 Safety & Environmental Information

The following topics can be found in this section:

“Warning Statements and Symbols” on page 10

“Safety” on page 11

“Environmental Conditions (Operating)” on page 13

“EMC (Electromagnetic Compatibility)” on page 14

“Instrument Location and Rack Mounting Requirements” on page 15

“Ventilation” on page 16

“Power Requirements” on page 17

“Using Accessories” on page 19

“Weight and Dimensions” on page 19

“Lifting” on page 19

“Protecting against electrostatic discharge” on page 20

“Protecting against excessive input power” on page 21

“Instrument Maintenance” on page 22

Warning Statements and Symbols

Caution and Warning notices are used in this document are described below.

CAUTION

A CAUTION notice denotes a hazard. It calls attention to an operating procedure, practice, or the like that, if not correctly performed or adhered to, could result in damage to the product or loss of important data. Do not proceed beyond a CAUTION notice until the indicated conditions are fully understood and met.

WARNING

A WARNING denotes a hazard. It calls attention to an operating procedure, practice or the like that, if not correctly performed or adhered to, could result in personal injury or death. Do not proceed beyond a WARNING notice until the indicated conditions are fully understood and met.

See also: [“Front and Rear Panel Symbols” on page 62.](#)

Safety

This product has been designed and tested in accordance with accepted industry standards, and has been supplied in a safe condition. The documentation contains information and warnings that must be followed by the user to ensure safe operation and to maintain the product in a safe condition.

Safety Compliance

This product complies with the essential requirements of the European Low Voltage Directive as well as current editions of the following standards (dates and editions are cited in the Declaration of Conformity):

- IEC/EN 61010-1
- Canada: CSA C22.2 No. 61010-1
- USA: UL std no. 61010-1

Acoustic statement (European Machinery Directive)

Acoustic noise emission
LpA <70 dB
Operator position
Normal operation mode per ISO 7779

General Safety Notices

WARNING

If this product is not used as specified, the protection provided by the equipment could be impaired. This product must be used in a normal condition (in which all means for protection are intact) only.

WARNING

No operator serviceable parts inside. Refer servicing to qualified personnel. To prevent electrical shock, do not remove covers.

Electrical Safety

See also: **“AC power safety” on page 18.**

NOTE

Measurement Category: None (not intended for Measurement Category II, III or IV). (That is, the E7515B input ports are not designed to measure hazardous voltages, or to be connected to equipment that is not protected from hazardous transient voltages.)

WARNING

This is a Safety Class 1 Product (provided with a protective earth ground incorporated in the power cords). The mains plugs shall only be inserted in socket outlets provided with a protective earth contact. Any interruption of the protective conductor inside or outside of the instrument is likely to make the instrument dangerous. Intentional interruption is prohibited.

WARNING

If this product is not used as specified, the protection provided by the equipment could be impaired. This product must be used in a normal condition (in which all means for protection are intact) only. Install the instrument so that the detachable power cords are readily identifiable and easily reached by the operator. The detachable power cords are the instrument disconnecting device. They disconnect the mains circuits from the mains supply before other parts of the instrument. The front panel switch is only a standby switch and is not a LINE switch. Alternatively, an externally installed switch or circuit breaker (which is readily identifiable and is easily reached by the operator) may be used as a disconnecting device.

CAUTION

This instrument has an auto-ranging line voltage input. Ensure the supply voltage is within the specified range and voltage fluctuations do not exceed 10 percent of the nominal supply voltage.

CAUTION

When installing the product in a cabinet the convection into and out of the product must not be restricted. The ambient temperature (outside the cabinet) must be less than the maximum operating temperature of the product by 4° C for every 100 watts dissipated in the cabinet. If the total power dissipated in the cabinet is greater than 800 watts, then forced convection must be used. It is your responsibility to ensure the ambient temperature does not exceed the rated ambient temperature stated in the specification.

WARNING

The Mains wiring and connectors shall be compatible with the connector used in the premise electrical system. Failure, to ensure adequate earth grounding by not using the correct components may cause product damage, and serious injury.

CAUTION

Use the Keysight supplied power cords or cords with the same or better electrical rating.

Environmental Conditions (Operating)

CAUTION

This product is designed for use in INSTALLATION CATEGORY II and POLLUTION DEGREE 2.

This product is designed for use in the following conditions:

- For indoor use only
- Altitude up to 2000 m (10,000 feet)
- Temperature 10° to 40° C
- Maximum Relative Humidity: 5% to 85% non-condensing
- OVERVOLTAGE CATEGORY II and Pollution degree 2

NOTE

From 40° C to 45° C, the maximum % Relative Humidity follows the line of constant dew point.

Environmental Information

Samples of this product have been type tested in accordance with the Keysight Environmental Test Manual and verified to be robust against the environmental stresses of Storage, Transportation and End-use; those stresses include but are not limited to temperature, humidity, shock, vibration, altitude and power line conditions.

Test Methods are aligned with IEC 60068-2 and levels are similar to MIL-PRF-28800F Class 3.

EMC (Electromagnetic Compatibility)

This product complies with the essential requirements of the European Directive as well as current editions of the following standards (dates and editions are cited in the Declaration of Conformity):

- IEC/EN 61326-1
- CISPR Pub 11 Group 1, class A
- AS/NZS CISPR 11
- ICES/NMB-001

This ISM device complies with Canadian ICES-001.

Cet appareil ISM est conforme a la norme NMB-001 du Canada.

CAUTION

This equipment is not intended for use in residential environments and may not provide adequate protection to radio reception in such environments.

South Korean Class A EMC declaration

This equipment has been conformity assessed for use in business environments. In a residential environment this equipment may cause radio interference.

※ This EMC statement applies to the equipment only for use in business environment.

사용자 안내문
이 기기는 업무용 환경에서 사용할 목적으로 적합성평가를 받은 기기로서 가정용 환경에서 사용하는 경우 전파간섭의 우려가 있습니다.

※ 사용자 안내문은 “업무용 방송통신기자재”에만 적용한다.

Declaration of Conformity

The Declaration of Conformity for any Keysight product can be found on the website:

<http://www.keysight.com/go/conformity>

Instrument Location and Rack Mounting Requirements

Locating the Test Platform

Make sure that the left-side panel fan inlet and right-side panel exhaust vent areas are not obstructed. The minimal required clearance is 2.75 inches (7 cm).

NOTE

Install the instrument so that the detachable power cord is readily identifiable and is easily reached by the operator. The detachable power cord is the instrument disconnecting device. It disconnects the mains circuits from the mains supply before other parts of the instrument. The front-panel switch is only a standby switch and does not act as a LINE switch. If needed, an externally installed switch or circuit breaker (which is readily identifiable and is easily reached by the operator) may be used as a disconnecting device.

Table Top Ambient Temperature

CAUTION

Do not exceed an ambient temperature of 40° C when operating the instrument on a table top.

Rack Mounting: Hardware and Temperature

If you choose to locate your test platform in a rack, follow the guidelines provided in this section.

Based on the type of equipment rack you have, you must determine what rack rails you need. If you are using a Keysight System Test Rack, you can find information on what to order by referring to the Rack Mounting Flange Kit (Option E7515B-1CM) Installation Note.

CAUTION

When mounting instrument in a rack, do not exceed the level of:
–Internal rack air temperature of 40°C

Ventilation

Do not rack mount the test platform side-by-side with any other instrument with side ventilation. Make sure the exhaust air from the first instrument is directed away from the inlet of the second unit. If the pre-heated air from the first instrument is directed into the second instrument, it can cause excessive operating temperatures in the second unit and can cause instrument failures. The test platform draws air in from the left side and exhausts air from the right side. Do not mount other equipment immediately above the instrument. The minimal required clearance is 2.75 inches (7 cm).

CAUTION

VENTILATION REQUIREMENTS: When installing the instrument(s) into a cabinet, consideration shall be given to the convection flow into and out of the cabinet. Consideration shall also be given to the individual instruments to avoid having the heated discharge of one instrument, now becoming the cooling intake air for another instrument.

Do not place the test set against any surface in such a way as to block its ventilation openings. Interfering with ventilation airflow can cause the test set to overheat.

Another area of concern is verification that the maximum ambient operating temperature of the instrument(s) is not exceeded by cabinet installation.

Keysight recommends forced air convection whenever an instrument(s) are installed in a cabinet and further recommends that the maximum operating temperature of the cabinet be reduced 10°C from the lowest, of the maximum operating temperature of a single instrument.

If there are any concerns or special requirements an Keysight Field Engineer should be consulted to assure instrument(s) temperature compliance and performance. used.

Power Requirements

The E7515B requires two AC power inputs, as illustrated below. Both AC inputs must be connected and powered to operate the instrument. If either of the two inputs is not present, the instrument will not boot (or will shut down, if already in operation). Two power cords are provided with the E7515B. See **“AC power safety” on page 18** for more information.

Figure 1-1 Dual AC inputs



Voltage & frequency: 100-240V~, 50-60 Hz, nominal

Power consumption: 2 x 900 W Max

NOTE

Mains supply voltage fluctuates up to +/- 10% of the nominal voltage. Transient over-voltages are typically present on the mains supply.

CAUTION

Be sure to comply with all recommendations included in **“AC power safety” on page 18**.

Older power supply

Some E7515B instruments have an older power supply design, which differs from the one described above in these particulars:

- There is only one AC input, not two. There is no need for a second power cord, or Y-adaptor, as described under **“AC power safety” on page 18**.
- There is no requirement for a grounding cable, as described under **“AC power safety” on page 18**.
- Power consumption is 1400 W Max

AC power safety

It is important to know the power capacity of the building's wiring facilities.

- For voltages below 200 V, two entirely separate power cords (provided with the E7515B) **must** be used. Make sure the plugs for each power cord are protected with **independent** and properly sized circuit breakers, with margin to provide the required power. Power strips are not allowed.
- For facilities with voltages above 200 V, a single power cord with a Y-adapter may be used to connect both of the instrument's AC inputs to a single wall plug. Make sure the circuit breaker for the line is properly sized, with margin to provide the required power.

WARNING

If a Y-adapter is used, a ground cable (not provided by Keysight) must be connected from the ground stud (at the lower left corner of the E7515B rear panel) to a proper ground socket of the building. Install the cable as illustrated below. The minimum required cross-section of the cable is 14AWG and O-ring size is M4.

Figure 1-2

Grounding cable (needed if a Y-adapter power input is used)



WARNING

The power cords are connected to internal capacitors which may remain live for 5 seconds after disconnecting the plugs from their power supply.

Using Accessories

Only Keysight approved accessories shall be used.

NOTE

Proper ergonomics should be considered when using accessories such as a keyboard or a mouse.

Weight and Dimensions

The weight and dimensions of the E7515B are as follows:

- Weight: 42.2 kg (with 2 cells)
- Height: 309 mm (323 mm with feet)
- Width: 436 mm (452.5 with lateral handles)
- Depth 554 mm

Lifting

As indicated by the "TWO PERSON LIFT" label, safety precautions must be taken in lifting or carrying the instrument.

WARNING

More than one person is required to safely lift or carry this instrument. Alternately a mechanical lift can be used to eliminate the risk of personal injury.

Figure 1-3 Lift warning label



Protecting against electrostatic discharge

Electrostatic discharge (ESD) can damage or destroy electronic components (the possibility of unseen damage caused by ESD is present whenever components are transported, stored, or used).

Test equipment and ESD

To help reduce ESD damage that can occur while using test equipment:

WARNING

Do not use these first three techniques when working on circuitry with a voltage potential greater than 500 volts.

- Before connecting any coaxial cable to a test set connector for the first time each day, momentarily short the center and outer conductors of the cable together.
- Personnel should be grounded with a 1 M Ω resistor-isolated wrist-strap before touching the center pin of any connector and before removing any assembly from the test set.
- Be sure that all instruments are properly earth-grounded to prevent build-up of static charge.
- Perform work on all components or assemblies at a static-safe workstation.
- Keep static-generating materials at least one meter away from all components.
- Store or transport components in static-shielding containers.
- Always handle printed circuit board assemblies by the edges. This reduces the possibility of ESD damage to components and prevent contamination of exposed plating.

Additional information about ESD

For more information about ESD and how to prevent ESD damage, contact the Electrostatic Discharge Association (<http://www.esda.org>). The ESD standards developed by this agency are sanctioned by the American National Standards Institute (ANSI).

Protecting against excessive input power

During UE testing in Power Class 1.5, the DUT may generate power levels high enough to exceed maximum RF input power at ports RF1 through RF8. To protect the E7515B receiver, a 4 dB attenuator should be connected in line with each UXM 5G RF port, when testing in Power Class 1.5. Recommended attenuators: BW-S4W5+ (SMA, 4dB) or BW-N4W5+ (N, 4dB).

CAUTION

If the attenuators described above are not used during testing at high power levels, the receiver section of the E7515B could be damaged.

After connecting the attenuators to the UXM 5G ports, please remember to refresh the system cal factors by running Cal Utility included in HCCU (Hardware Configuration Utility) software. This will update system to include the extra power loss in paths with added attenuators. (These attenuators are not supplied with the UXM 5G.)

Instrument Maintenance

Cleaning the Instrument

WARNING

To prevent electrical shock, disconnect the instrument from mains before cleaning. Use a dry cloth slightly dampened with water to clean the external case parts. Do not attempt to clean internally.

Cleaning the connectors

NOTE

Cleaning connectors with alcohol shall only be done with the instrument's power cord removed, and in a well-ventilated area. Allow all residual liquid alcohol to evaporate and the fumes to dissipate prior to energizing the instrument.

2 Quick Start

This section describes how to set up your UXM 5G, install product licenses, and provide test platform maintenance. You can also contact your Keysight representative to obtain on-site start-up assistance to help you with all steps outlined in this section, which is included with your UXM 5G purchase.

The following topics can be found in this section:

[Overview on page 24](#)

[Initial Inspection on page 25](#)

[Turning On the Test Platform the First Time on page 31](#)

[Licensing on page 37](#)

[LAN Connectivity on page 39](#)

[Windows Updates on page 40](#)

[Anti-virus Protection and Firewalls on page 42](#)

[UXM 5G Applications on page 27](#)

[Reference Documents on page 43](#)

Overview

The purpose of this guide is to provide you with the basic steps for getting started with the Keysight E7515B UXM 5G Wireless Test Platform, and to tell you where you can go to get additional information. It also provides first-time power on instructions, licensing information, operating system information, and general hardware information.

Figure 2-1 Keysight E7515B UXM 5G Wireless Test Platform



Purpose and Function

The E7515B UXM 5G wireless test platform provides the signaling and measurement core for Keysight's 5G network emulation solution portfolio.

Initial Inspection

Inspect the shipping container and the cushioning material for signs of stress. Retain undamaged shipping materials for future use, as you may wish to ship the test platform to another location or to Keysight Technologies for service.



Verify the contents of the container against the table below.

WARNING

This instrument is heavy. Two people are required to lift this instrument.

WARNING

Please consult ergonomic guidelines regarding placement of the external keyboard when using it with the instrument. Using the keyboard in an uncomfortable or awkward environment could result in personal injury.

Item	Deliverable	Description
Keysight E7515B UXM 5G Wireless Test Platform		
License entitlement certificate(s)		You must register your instrument purchase using the included entitlement certificate. Follow the instructions on the Certificate. If this is your first visit to the license management website, you will be required to register. Refer to “Licensing” on page 37 for more information.
Keysight Test USIM card, tri nano (E7515-10910)	See www.keysight.com/find/usim for details.	
Test USIM card, tri nano IM card (T1099-10001)		
AC Power Cable (2)		Connection for Instrument Power

Shipping Problems?

If the shipping materials are damaged or the contents of the container are incomplete:

- Contact the nearest Keysight Technologies office.
- Keep the shipping materials for the carrier's inspection.
- If you must return a test platform to Keysight Technologies, use the undamaged original or comparable shipping materials. See **“Returning Your Test Set for Service” on page 85.**

UXM 5G Applications

The UXM 5G operates within the C8700200A 5G Test Application Framework. Different capabilities of this framework are licensed separately.

NOTE

You must purchase a Test Application license to use its features in the UXM 5G.

About the test applications

The applications run on the embedded Windows controller present in the UXM 5G (or on an external test PC connected to the UXM 5G). The applications use the provided touch-screen based interface, integrated fading, network emulation and measurement capabilities present in the test platform to provide you with a simple to use, bench-top design verification tool.

Installing the test applications

This software comes already installed on your UXM 5G. If there is a problem and you need to re-install it, refer to Installing the Software on [“Updating the Keysight E7515B UXM 5G software” on page 77](#).

RF Interface

The MSB and RFB cards provide the digital signal processing needed for generation of up to 8 Tx signals, by way of the Digital/Analog Converters (DACs), and also for reception/measurement of up to 4 Rx signals, by way of the Analog/Digital Converters (ADCs).

The Tx/Rx ports on the front panel (RF 1-8, on the right in the diagram) connect with the DACs and ADCs through a network of switches and combiners in the RFIO card.

Any port can operate in transmit mode. Up to 4 ports at a time can operate in receive mode (RF 1 or 5; RF 2 or 6; RF 3 or 7; RF 4 or 8). Any RF port can operate in full-duplex mode, if it is configured as both an input port and an output port (but only 4 ports at a time can do this, because of the limitation of 4 ports in receive mode).

CAUTION

Excessive input power to the RF ports can cause receiver damage. See **“Protecting against excessive input power”** on page 21.

Figure 2-2 RF Interface

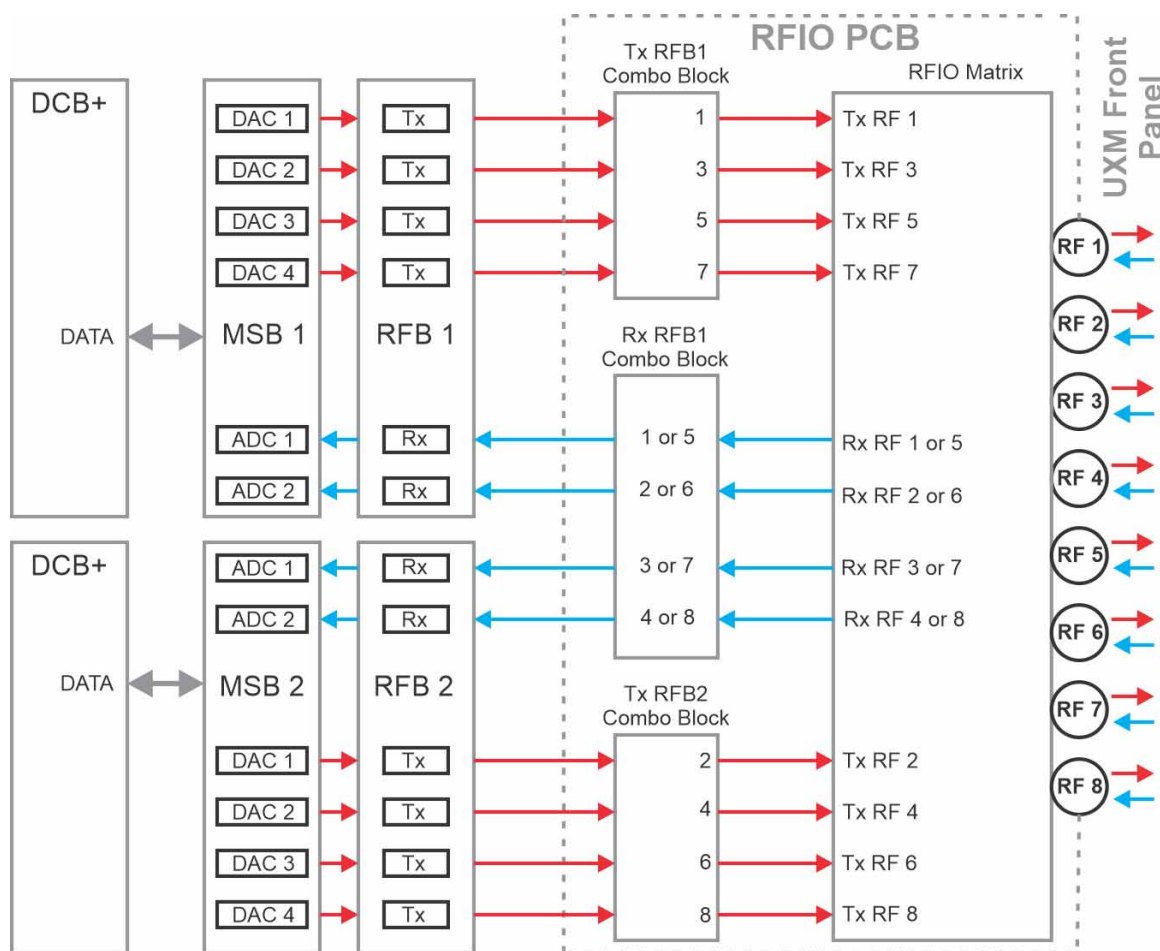

Millimeter-Wave Accessory Instruments

The E7515B (UXM 5G) supports a wide variety of testing scenarios in regard to the way antennas are routed to transmit and receive ports on the front panel. Full duplex and half duplex modes are possible at any port. Up to 4 antennas can be used as receivers and 8 antennas can be used as transmitters.

For testing at higher frequencies than the E7515B itself can generate, two other instruments are commonly used with the E7515B: the M1740A mmWave Transceiver (usually called the Remote Radio Head or RRH) and the E7770A Common Interface Unit (usually called the CIU).

Figure 2-3 E7515B used with M1740A (bottom) and E7770A (top)



As illustrated below, the CIU is able to upconvert the RF output of the UXM 5G to the 6-12 GHz range and apply this signal to the DUT. On the same path, it also can accept a return signal from the DUT, downconvert it to the range of the UXM 5G, and return it to an input port on the UXM 5G.

Figure 2-4 Functional block diagram of E7515B and E7770A

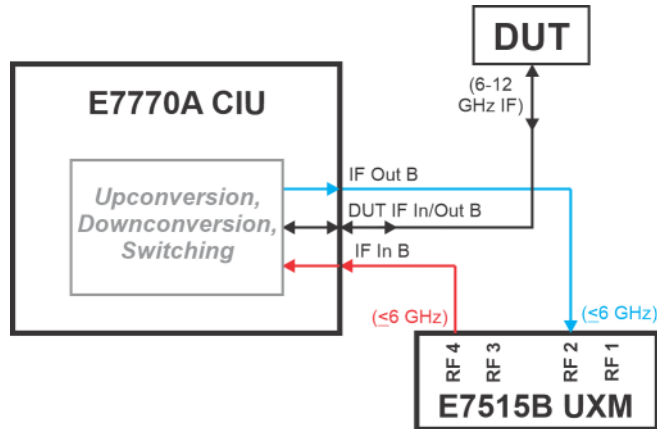

For mmWave testing, the RF output of the UXM 5G does not need to be upconverted by the CIU, so it bypasses the CIU (which in this case is used only to generate the combined LO, DC Power, and Control inputs which the M1740A requires). The RF output is upconverted by the M1740A to the mmWave range, and is supplied to an antenna OTA (wireless) interfacing with the DUT). The returned mmWave signal is received by the M1740A, downconverted, and passed back to the UXM 5G RF input.

Figure 2-5 Functional block diagram of E7515B, M1740A, and E7770A

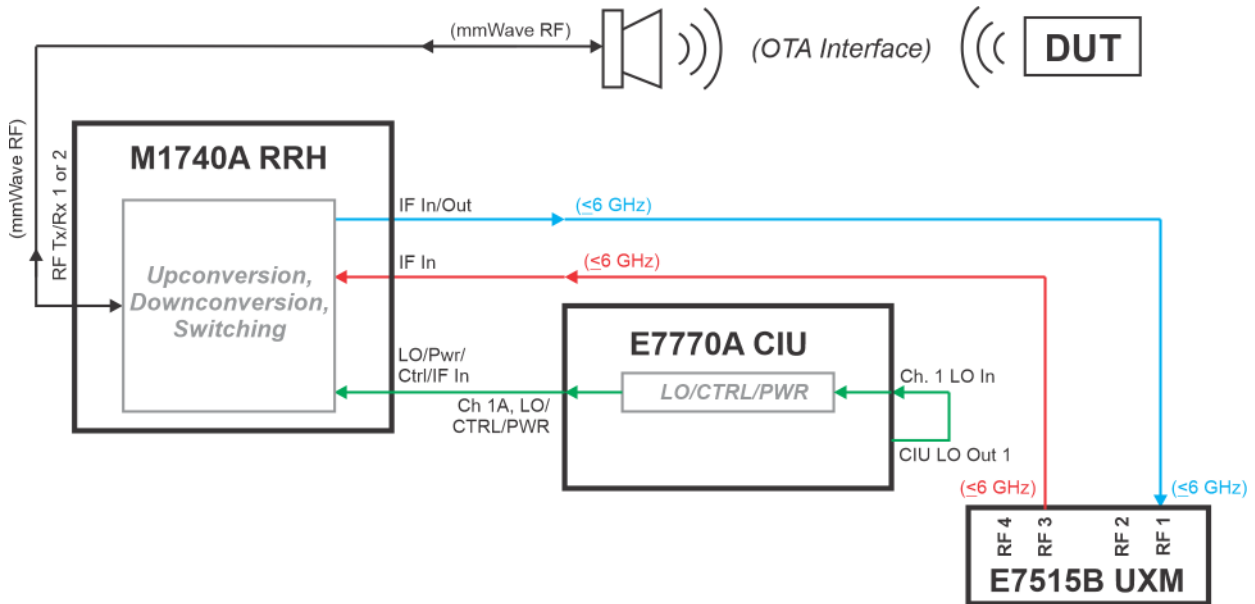

Turning On the Test Platform the First Time

CAUTION

DO NOT remove the AC power during boot-up/shutdown of the operating system or during the process of initializing the software. This can cause damage to the system files and prevent proper operation of the instrument.

CAUTION



Before switching on this instrument, make sure the supply voltage is in the specified range.

Step	Action	Notes
1. Connect power cable	Install the instrument so that the detachable power cord is easily reached by the operator.	Ensure power outlet is provided with a protective ground as specified.
2. Connect the mouse and the keyboard (Optional).	Connect the mouse and the keyboard to the test platform's USB ports.	
3. Power on the test platform	<p>Position the test platform so you have easy access to the power cord and plug it in.</p> <p>Press the power button (bottom right of instrument front panel) when the LED above the power button illuminates in yellow. (It is best to wait at least 3 seconds after the LED is yellow before pressing the power button.)</p>	<p>See “Instrument Location and Rack Mounting Requirements” on page 15 and “Power Requirements” on page 17.</p> <p>Front-panel power button:</p> 

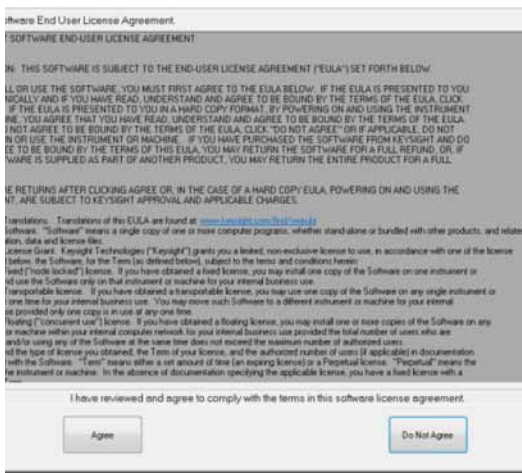
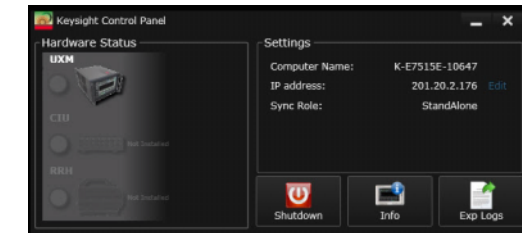

Quick Start
Turning On the Test Platform the First Time

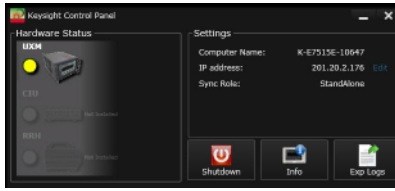
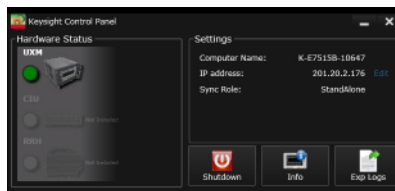
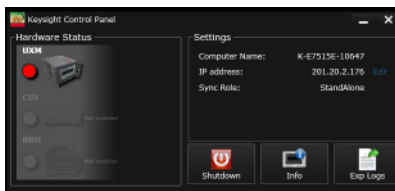
Step	Action	Notes
4. You will be prompted to accept the End User License Agreement (EULA).	Select the Agree button to indicate that you accept the license agreement.	 <p>The screenshot shows a window titled "End User License Agreement". The text includes: "SOFTWARE END-USER LICENSE AGREEMENT", "THIS SOFTWARE IS SUBJECT TO THE END-USER LICENSE AGREEMENT ('EULA') SET FORTH BELOW", and "IF YOU AGREE THAT YOU HAVE READ, UNDERSTAND AND AGREE TO BE BOUND BY THE TERMS OF THE EULA, CLICK 'I AGREE'". At the bottom, there are two buttons: "Agree" and "Do Not Agree".</p>
		<p>After you agree to the EULA, the operating system boots-up and you see a black background with Keysight Technologies logo displayed on the screen. The E7515B Control Panel (shown below) is overlaid on top of this Keysight screen and remains visible while the internal hardware boards of the UXM 5G are booted-up.</p>
		 <p>The screenshot shows the "Keysight Control Panel" window. On the left, under "Hardware Status", there are three sections: "UXM" (with a power icon), "CPU" (with a power icon), and "BRU" (with a power icon). On the right, under "Settings", there are three fields: "Computer Name: K-E7515E-10647", "IP address: 201.20.2.176" (with an "Edit" button), and "Sync Role: StandAlone". At the bottom right, there are three buttons: "Shutdown", "Info", and "Exp Logs".</p>

Quick Start
Turning On the Test Platform the First Time

Step	Action	Notes
<p>5. Wait until you see the green or red color displayed in the UXM 5G pictorial graphic, located in the upper left corner of the E7515B Control Panel.</p>	<p>The changing colors of the E7515B Control Panel pictorial graphic indicate the “ready-state” of the UXM 5G.</p>	<p>Yellow indicates the UXM 5G is in the process of becoming ready for operation.</p>
		
		<p>Green indicates the UXM 5G is ready for operation.</p>
		<p>Red indicates an error has occurred in the system and the unit is not ready for operation. (This requires troubleshooting, as the problem is not expected to resolve on its own.)</p>
<p>6. Make sure all required Windows updates are made.</p>	<p>Windows must be configured properly on your instrument to ensure this.</p>	<p>Windows updates are necessary to protect your E7515B instrument against the latest malware and viruses. See “Windows Updates” on page 40.</p>
<p>7. Run the HCCU.</p>		<p>Activate the Keysight NES Hardware Configuration Control Utility by double-clicking the Keysight HCCU icon on the desktop. (This utility runs within a browser window.)</p> <p>Microsoft Internet Explorer is not recommended as the browser for this utility, because of known compatibility issues. The recommended browser is Google Chrome.</p>
<p>8. If necessary, install the Google Chrome browser.</p>	<p>The browser can be downloaded from: https://www.google.com/chrome/browser/</p> <p>After installation, set up Chrome as the default browser (Google provides setup instructions for this).</p>	

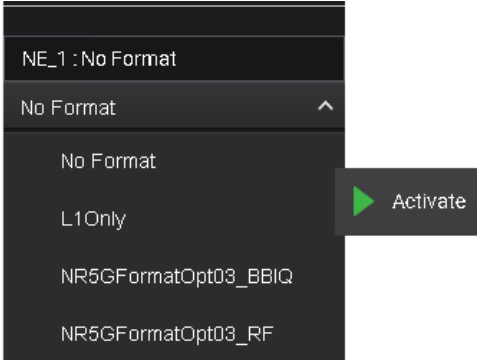
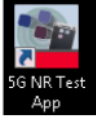

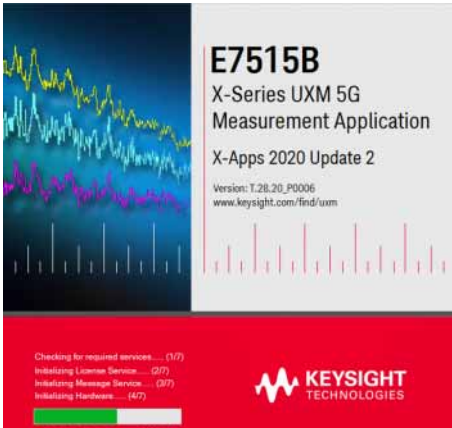
Quick Start
Turning On the Test Platform the First Time

Step	Action	Notes
<p>9. Select a scenario.</p>	<p>In the HCCU, on the Scenarios tab, select a testing scenario (such as NR5GFormatOpt03_RF) and click the Activate icon. Wait while the selection is set up (an "in progress" message is displayed while the scenario is being activated).</p>	
<p>10. Run the test application.</p>	<p>Activate the test application by double-clicking on the 5G NR Test App icon.</p> <p>There is a lengthy delay while the software loads.</p>	
<p>11. Run the HCCU.</p>	<p>Activate the Keysight NES Hardware Configuration Control Utility by double-clicking the Keysight HCCU icon on the desktop. (This utility runs within a browser window.)</p>	
<p>12. Wait for the application to load.</p>	<p>Later in the loading process, a splash-screen is displayed (with a progress indicator).</p>	

Quick Start
Turning On the Test Platform the First Time

Step	Action	Notes
13. Begin using your new software after the splash screen disappears.	For detailed information on how to use the software, refer to the 5G NR Test Application Help.	

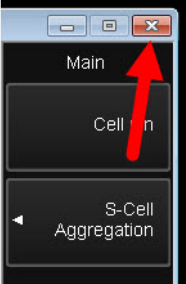
Shutting Down the Test Platform

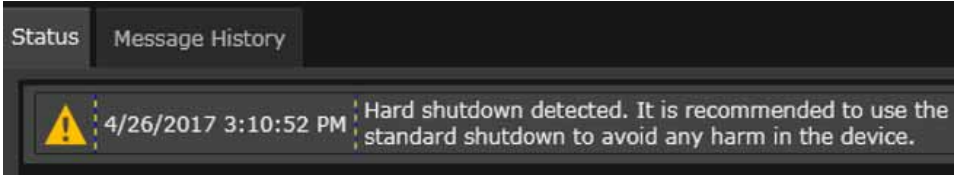
Step	Action	Notes
<p>1. Close the test application by clicking on the "X" button at the upper right.</p>		
<p>It is recommended that you press the front-panel power button, or select Shutdown from the MS Windows Start menu, or select the Shutdown icon on the E7515B Control Panel (as illustrated here).</p>	<p>The display will show the windows shut-down screen.</p>	
<p>To force power off: press and hold the front-panel power button for at least 60 seconds.</p>	<p style="text-align: center;">CAUTION</p>	<p>Do not force power off in this way unless the normal procedure fails (a forced shutdown carries a risk of corrupting hard-drive data). If the last power shutdown was done in that way, the message shown below will be displayed on power-up as a reminder.</p>
		

Licensing

All licenses required to operate your UXM 5G have been installed at the factory (except transportable licenses – see below) and can be recovered using one of the procedures outlined in **Chapter 5, “Test Platform Operating System”, on page 65**. Complete these steps if you need to add licensing to your UXM 5G:

1. Follow the directions located on the license entitlement certificate that you received with the delivery of your UXM 5G.

NOTE

You may register or sign in with your profile at:

www.keysight.com/find/softwaremanager

in order to obtain any software updates and/or new licenses using your entitlement details.

2. In order to redeem a license unique to your UXM 5G, you will need to enter the “Host ID”. To determine the Host ID of your UXM 5G, select the License Manager icon located on the E7515B Control Panel (see **“Control Panel Icons” on page 47**.) The Keysight License Manager (KLM) window opens and displays your Host ID:

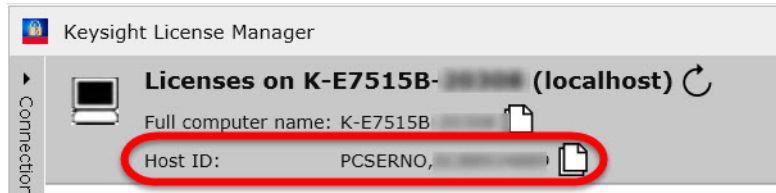

3. After the registration/sign-in/filling in information, an e-mail with the generated license file will be sent to you. You need to copy the license file to the root directory of a USB memory stick and then insert the USB memory stick into the UXM 5G. It will automatically install any licenses that it finds on the USB memory stick for the test platform.

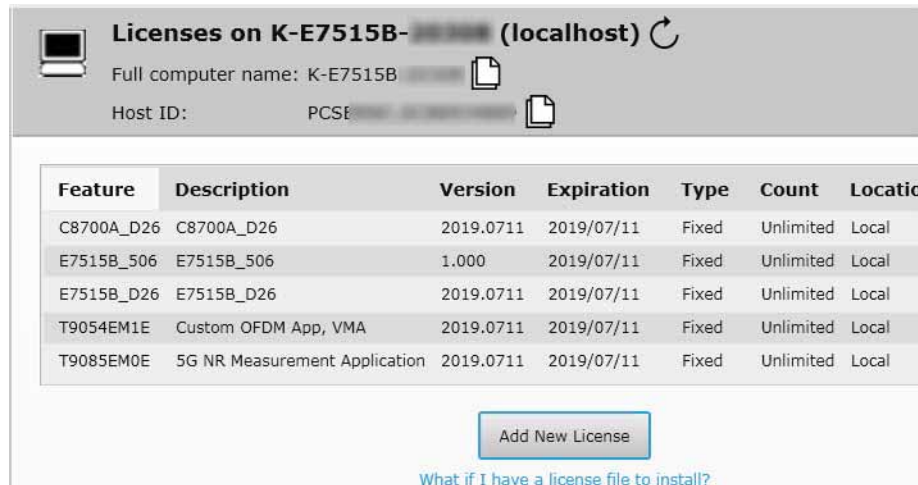

Transportable Licenses

Transportable licenses are identifiable by the “T” included in their license numbers (for example: C8702000A-1TP). This type of license enables you to move the license from one host instrument or PC to another, without the need to contact Keysight. Follow the steps above to install the transportable license for the first time.

To transport a license after that installation, run Keysight License Manager on the host that currently has the license, and transport the license. (Select **Help > Keysight License Manager Help** and search for “transport” to find detailed instructions.)

NOTE

Transportable licenses for the E7515B UXM 5G allow you to transport licenses up to 30 times within the previous 10 days.

You can also save a transportable license to Keysight Software Manager (KSM) for later assignment to a host. To do so, review the Transporting Licenses section (found as described above) in the Keysight License Manager Help. When you are asked to choose a destination for the license, select **Save the license to Keysight Software Manager**.

When you are ready to assign the license to a host, come back to KSM and look for the action bubble entitled **You can request new licenses**. Click the bubble and follow the instructions given.

Other related topics for managing your software and licenses can be found by reviewing the Keysight License Manager Help available from the **Help** drop-down menu of the KSM software.

LAN Connectivity

The UXM 5G has two network interface cards (NICs) that connect the instrument Host PC (embedded PC module) to external LAN outputs.

If your site network supports Dynamic Host Configuration Protocol (DHCP), these front and rear LAN ports are assigned IP addresses automatically when they are connected to the LAN.

Connect the LAN lines as shown below. (You need only one connection from the UXM 5G Host PC: either the front-panel LAN or the Rear-Panel LAN.)

Figure 2-6 LAN configuration

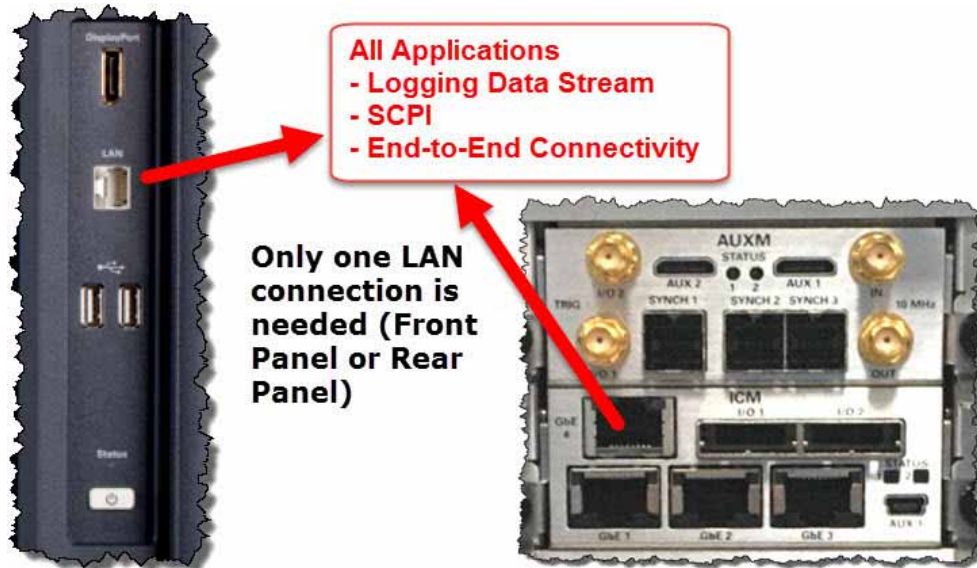

Corporate Domains

CAUTION

It is strongly recommended that the UXM 5G Host PC should not be added to any corporate domain. Doing so may result in undesirable operation procedures, or first-time test application software launch failures.

CAUTION

Adding the Host PC to a domain may force installation of conflicting software (for example: firewalls or anti-virus software). In such cases adding to a domain must be avoided.

Once the UXM 5G Host PC has been added to a domain, the domain may enforce certain Windows security or user policies. If this occurs, it is not sufficient to remove the PC from the domain – a system recovery is required, to fully restore the settings to a known working condition. (See **“Disk Drive Recovery Process”** on page 92.)

Windows Updates

To ensure that your E7515B instrument is protected against the latest malware and viruses, it is recommended to install all the Windows critical updates.

1. Go to **Windows/Start** and type "Update"; click on the displayed **Windows Update** link:

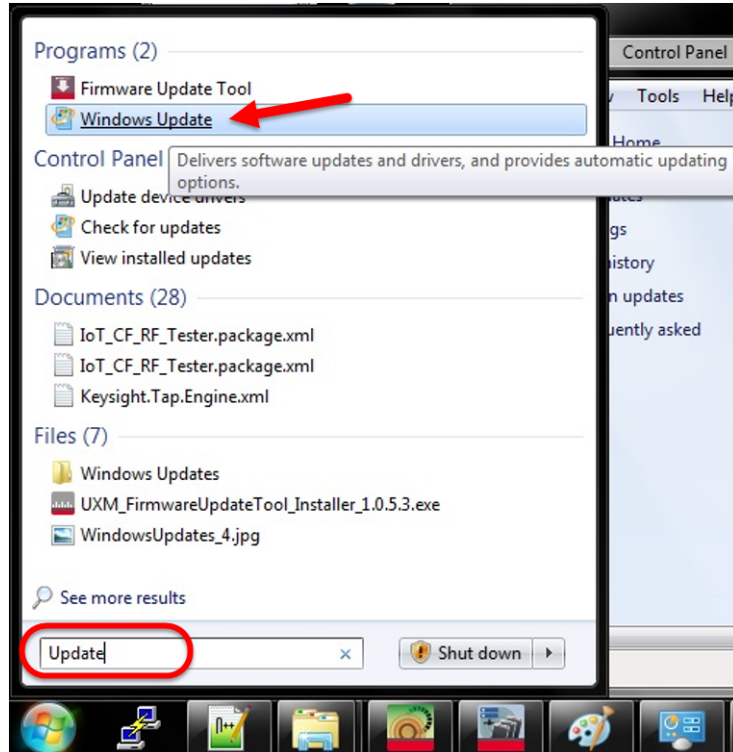

2. Select **Check for updates** in the left side menu, and follow the on-screen instructions to download and install the Windows updates.



3. In order to keep your instrument protected, select **Change settings** in the left side menu:



4. Under **Important updates**, select the option **Check for updates but let me choose whether to download and install them**.

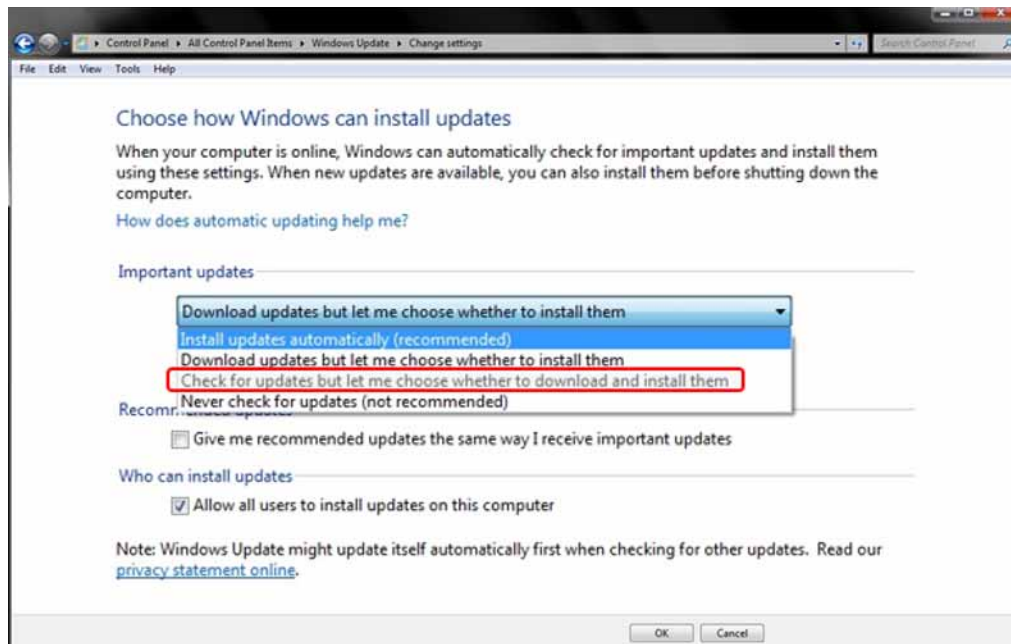

NOTE

Current Keysight policy sets the Windows Update settings to “Check for updates but let me choose whether to download and install them” in “Important updates”. If your UXM 5G is not configured per the current Keysight policy, please set the Windows Update settings accordingly.

Anti-virus Protection and Firewalls

The instrument is shipped with the Windows 10 firewall disabled. No anti-virus software is shipped with the instrument. It is recommended that you do not enable anti-virus protection for normal operation.

CAUTION

Take care to verify that USB memory devices used with the UXM 5G are virus-free before using with the instrument.

Connecting the test platform directly to the public LAN is potentially insecure, because the test platform does not provide anti-virus protection. It is preferred that you connect the test platform to the public LAN by way of a PC with antivirus protection.

The instrument internally operates using fixed IP addresses for the following NICs. Do not modify the default network settings for the following connections, as this will cause problems with the operating system of the test platform:

- Host PC:
 - Internal_NIC

Reference Documents

More detailed information about the test platform is available on the Document Library tab of this web page:

<http://www.keysight.com/find/E7515B>

Quick Start
Reference Documents

3 Control Panel Functions

The following topics can be found in this section:

“Viewing the Control Panel” on page 46

“Control Panel Icons” on page 47

The Control Panel

Figure 3-1 The UXM 5G Control Panel

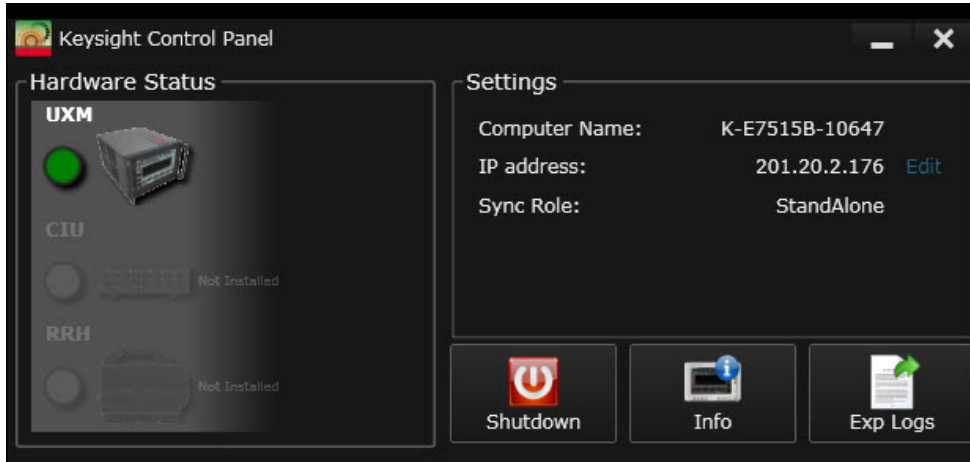

The E7515B Control Panel enables you to interact with and manage the hardware components of the UXM 5G. It is always running if the test platform is turned on. If it is not displayed on the screen, it is minimized in either the lower left or right area of the Windows task bar.

NOTE

The control panel lists "Sync Role" information under **Settings** as shown above, but the current version of the control panel is no longer used to place the UXM 5G in an array, or to remove it from an array and return it to StandAlone mode. See ["UXM Arrays" on page 67](#) for information on that topic.

Viewing the Control Panel

Right-click on the E7515B Control Panel icon  from the task bar and select **Open Control Panel**.

NOTE

To access the Windows task bar from inside the test application, you can use the Application Switch tool to switch to the desktop and find the task bar, or you can connect the USB keyboard to the UXM 5G using one of the USB ports located on the front and rear panels of the UXM 5G. Press the key showing the Windows

icon , which is usually located in the lower-left corner of the keyboard.



NOTE

If the E7515B Control Panel icon is not present in the task bar or on the desktop, it can be opened by selecting the Windows **Start Menu**, **All Programs**, **Keysight E7515B Platform**, **E7515B Control Panel**.

Control Panel Icons

The functions listed in the table below are available by selecting the various E7515B Control Panel icons. For more information about these functions, see the "E7515B UXM 5G Wireless Test Platform - User's and Programmer's Guide", which is available in the Document Library tab of this site:

<http://www.keysight.com/find/uxm>

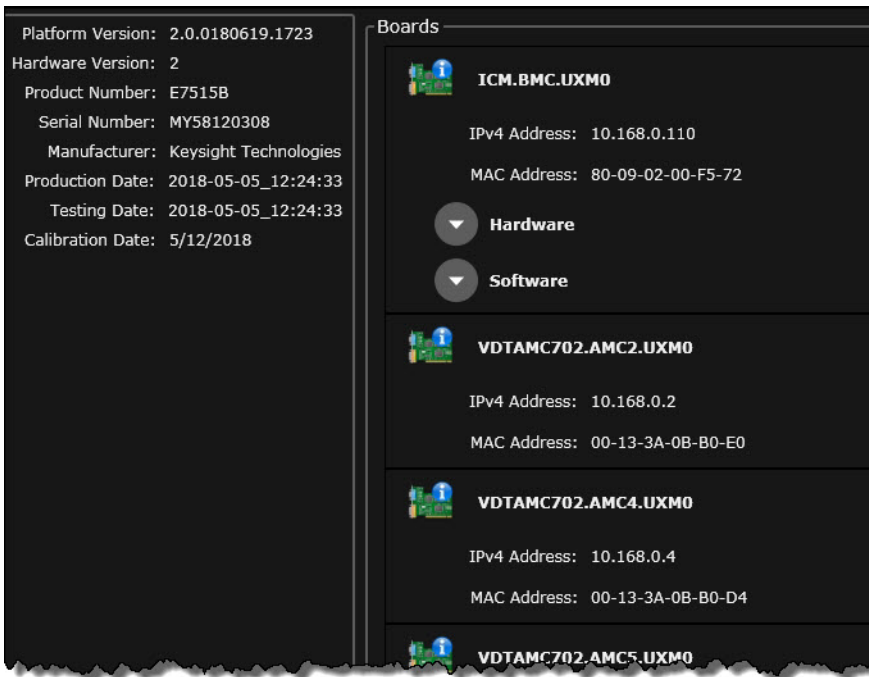
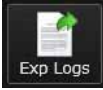
Icon	Description
	<p>Shuts down the UXM 5G hardware and software. It is recommended that you close all application software before selecting this E7515B Control Panel option.</p> <p>As a shutdown is a "destructive" operation, you will be asked to click "Ok" in a confirmation window ("This action will shut down Windows. Do you want to continue?".)</p>
	<p>Opens window with two options for obtaining instrument traceability information. Use this information when you need to discuss your test platform with an authorized Keysight representative. Below is a partial example of what you might see displayed.</p> <div data-bbox="483 856 1347 1528"><p>The screenshot shows a window with two panes. The left pane lists platform and hardware information: Platform Version: 2.0.0180619.1723, Hardware Version: 2, Product Number: E7515B, Serial Number: MY58120308, Manufacturer: Keysight Technologies, Production Date: 2018-05-05_12:24:33, Testing Date: 2018-05-05_12:24:33, Calibration Date: 5/12/2018. The right pane is titled 'Boards' and lists three boards: ICM.BMC.UXM0 (IPv4: 10.168.0.110, MAC: 80-09-02-00-F5-72), VDTAMC702.AMC2.UXM0 (IPv4: 10.168.0.2, MAC: 00-13-3A-0B-B0-E0), and VDTAMC702.AMC4.UXM0 (IPv4: 10.168.0.4, MAC: 00-13-3A-0B-B0-D4). A fourth board, VDTAMC702.AMC5.UXM0, is partially visible at the bottom.</p></div>
	<p>Opens a file window at <code>C:\Users\Administrator\Desktop\ngp\fr1_celloff_2cc_error</code> which enables you to browse to a different location or to designate this location to save a zipped set of encrypted log files from the instrument. These files can be used to assist Keysight with remote diagnosis of instrument problems. The .zip file is password-protected; the password is: Keysight4u!</p>

Control Panel Functions
The Control Panel

4 Front and Rear Panel Functions

The following topics can be found in this section:

[“Front Panel Features” on page 50](#)

[“Rear Panel Features” on page 53](#)

[“Front and Rear Panel Symbols” on page 62](#)

Front Panel Features

Begin using the UXM 5G by becoming familiar with the layout of the Front Panel and the displayed user interface.

Figure 4-1 UXM 5G Front Panel



Front and Rear Panel Functions
Front Panel Features

Number	Item Name	Description
1	Touch-screen	LCD Flat-Panel Display with single touch 15" capacitive touch-screen.
2	DisplayPort	This is a DisplayPort output, which transfers uncompressed video and audio data to an external display, such as a PC monitor or projector.
	NOTE	If a monitor is going to be connected to the DisplayPort, it is preferable to make this connection while instrument power is off . The monitor is normally detected by the E7515B's power-on routine; it can sometimes go undetected if the connection is made after power is on (if that happens, it will be necessary to cycle power on the E7515B so that the power-on routine is repeated).
3	Front LAN Connection	This RJ-45 connector provides front-panel access from the UXM 5G Host PC enabling a maximum Ethernet data rate of 1 Gigabit. This connector is used for downloading firmware upgrades, new test platform applications, saving data to an external memory drive and other reasons for which you may wish to connect to a local area network and/or to the internet. See “LAN Connectivity” on page 39 . The IP address for this input is labeled “Front”.
4	2 - USB Inputs	Universal Serial Bus inputs for peripheral devices (mouse, keyboard, flash drives). These are USB version 2.0. (See the rear panel for USB 3.0 ports.)
5	Power button	The power button is the On/Off button for AC power. Pressing this button when the instrument is powered off turns it on. Pressing this button briefly will shut down the UXM 5G and Windows Operating System safely. (Pressing and holding this button down for 60 seconds forces a complete instrument shut-down, but this is not recommended, as it triggers an uncontrolled Windows shutdown).
	Status light	The Status light indicates the power status of the instrument (see “Power Status Indicator” on page 52). The line power must be connected in order for this light to illuminate.
6 -13	RF1 - RF8 Tx/Rx ports	These ports transmit and receive using the base station emulator of the UXM 5G.
	In/Out lights	For each port, two indicators are provided; they are lit when the port is configured to receive (In), to transmit (Out), or to operate in duplex mode (both).

CAUTION

For ports RF1 through RF8, the maximum RF power input levels are:
+34 dBm MAX CW, +42 dBm MAX Peak, +20 VDC MAX
Excessive input power can damage the receiver.
See **“Protecting against excessive input power” on page 21**.

Power Status Indicator

UXM 5G Power Status

- **Off:** The power cord is unplugged.
- **Yellow:** The power cord is plugged in, but the UXM 5G is powered down (its front-panel power button is off). The first time line power is provided (with the power switch off), the indicator may display as green when the Micro-Controller Unit is loading (~3 seconds), after which it remains yellow.
- **Green blinking:** The UXM 5G is booting up.
- **Green:** UXM 5G is available for use or in use.
- **Green/Yellow blinking:** Instrument Control Module (ICM) for the Micro-Controller Unit is downloading firmware. (Not the FPGA ICM.) When the FPGA-ICM is downloading firmware, the LED is green.
- **Yellow blinking:** UXM 5G is shutting down and the boards shutdown process has begun.
- **Yellow/Orange blinking:** UXM 5G is off after an abnormal shutdown.

Rear Panel Features

Figure 4-2 Slot numbers

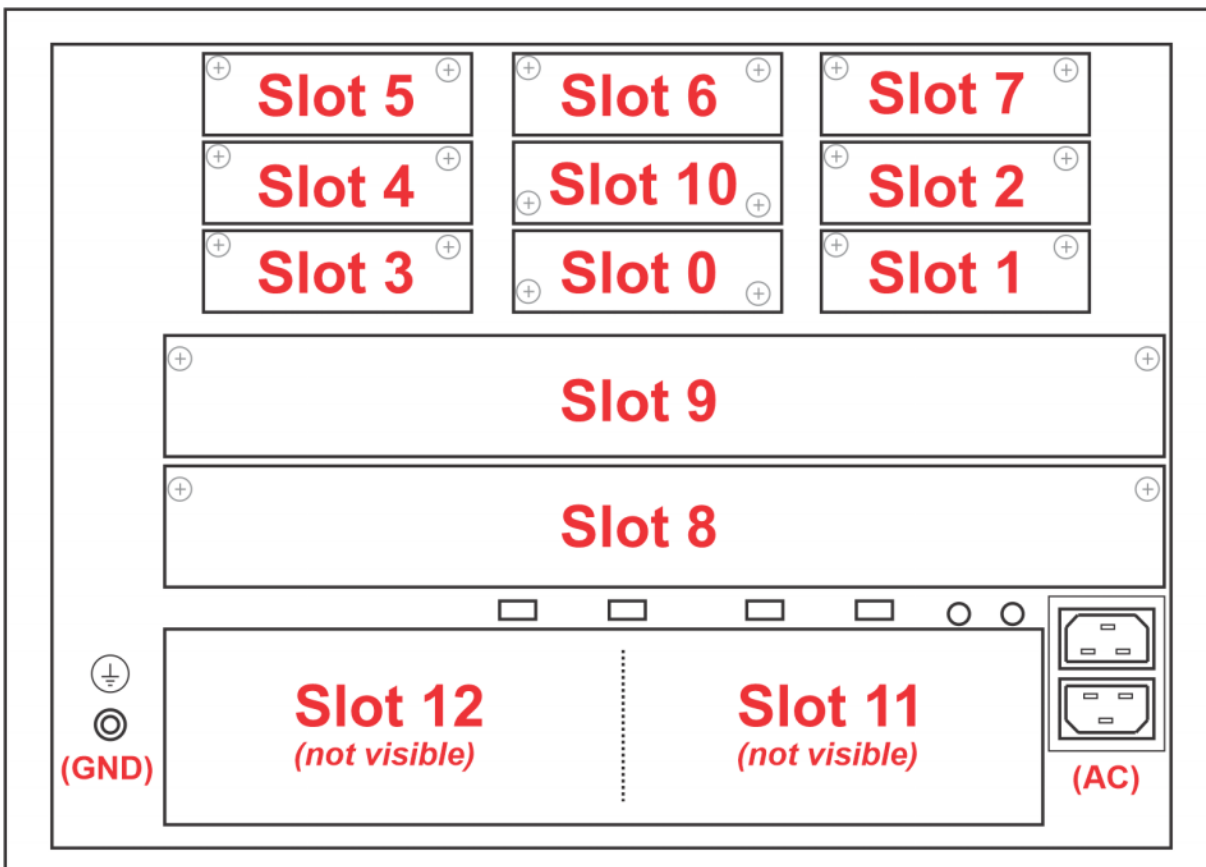

The slot numbers for the different sections of the rear panel that are marked in the illustration above; they are described in the following sections.

CAUTION

Do not cover or block the air flow vents. The test platform draws air in from the left side and exhausts air from the right side.

NOTE

The main power cord can be used as the system disconnecting device. It disconnects the mains circuits from the mains supply.

Slot 0: ICM Connectors

Figure 4-3 UXM 5G Rear Panel -- ICM Connectors

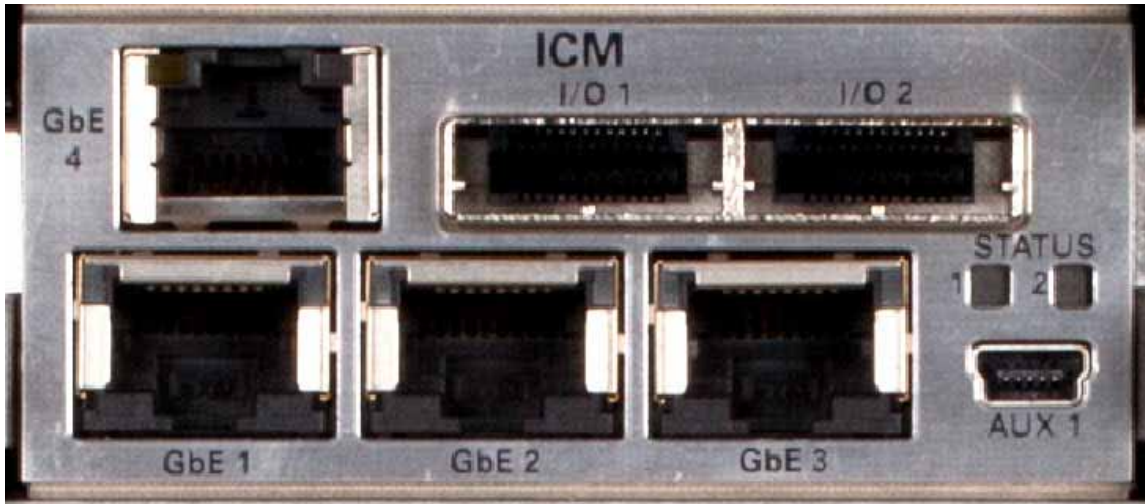

These connectors relate to the AUXM circuit board within the UXM 5G.

Name	Description	Notes
GbE 4	This is the Ethernet port that is connected internally to the UXM 5G Host PC. Use this port to connect the UXM 5G to the LAN.	The IP address for this input is labeled "ICM GbE4".
I/O 1 I/O 2	Mini-SAS 28AWG	Used to interconnect multiple UXM 5G units.
STATUS 1 STATUS 2	LEDs	(Reserved for future use.)
AUX 1		(Reserved for future use.)
GbE 1 GbE 2 GbE 3	Ethernet GbE 1, GbE 2, and GbE 3	Used only by Keysight during production or maintenance..

Slots 1, 3: FPGA Expansion Module (E7515B-FP1)

Figure 4-4 UXM 5G Rear Panel -- E7515B-FP1 card connectors



These connectors relate to the optional FPGA expansion module (E7515B-FP1), of which there are potentially two, located in slots 1 and 3. These modules expand the FPGA capacity of the E7515B, for certain kinds of 5G testing which require this.

Name	Description	Notes
QSF1	QSFP Interface	Reserved for future use.
QSF0	QSFP Interface	Reserved for future use.
TRIG 1	TBD	Reserved for future use.
DEBUG	Service port	For use by Keysight service engineers
TRIG 0	TBD	Reserved for future use.

Slots 2, 4, 5: VDTAMC Cards

Figure 4-5 UXM 5G Rear Panel -- VDTAMC card connectors

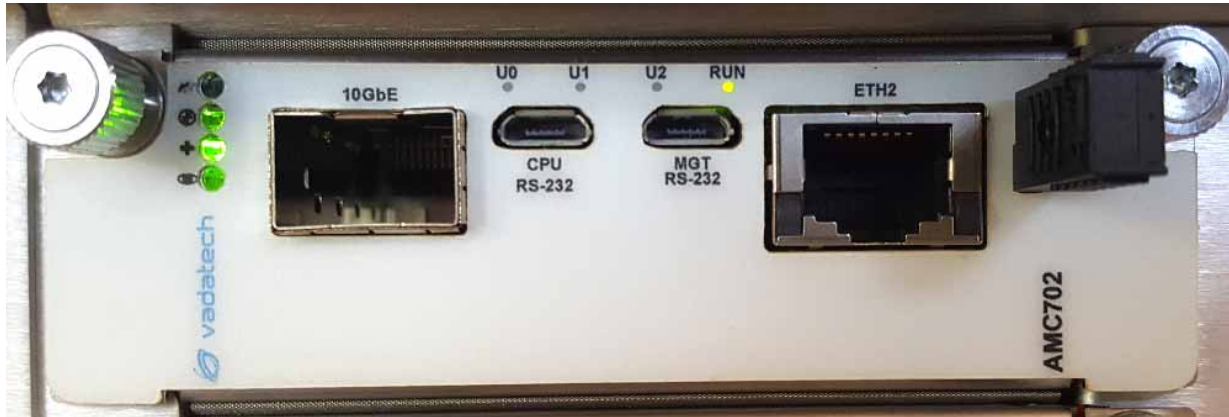

These connectors relate to the VDTAMC card (of which there are three, in slots 2, 4, and 5) within the UXM 5G.

The VDTAMC card (also known as the Vadatech AMC 702) handles processing of the PHY and PDCP layers in the simulated 5G NR stack.

Name	Description	Notes
10GBbE	SFP+ connector	Usage depends on the hardware configuration selected on the HCCU Setup tab.
U0, U1, U2, RUN	LEDs	(Reserved for future use.)
CPU RS-232	Micro-USB connector	(Reserved for future use.)
MGT RS-232	Micro-USB connector	(Reserved for future use.)
ETH2	RJ-45 connector	Usage depends on the hardware configuration selected on the HCCU Setup tab.

Slot 7: CCTAMC Card

Figure 4-6 UXM 5G Rear Panel -- CCTAMC card connectors

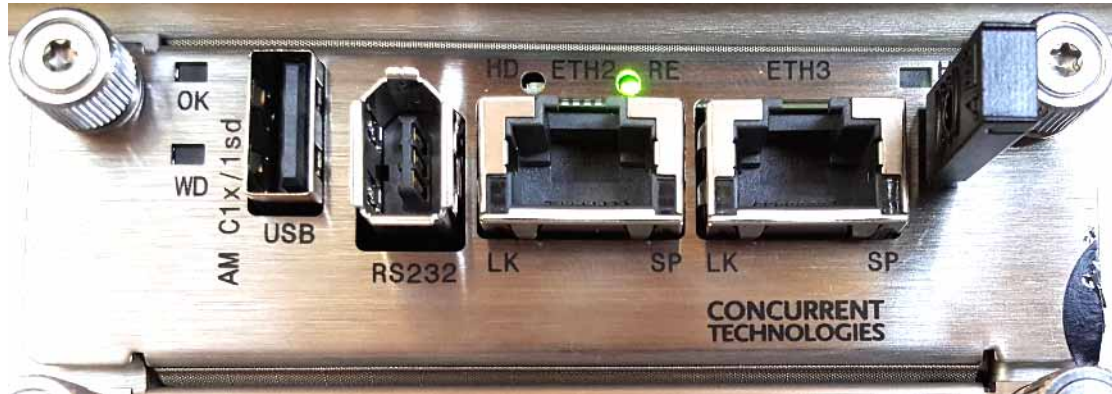

These connectors relate to the CCTAMC card within the UXM 5G.

The CCTAMC card (also known as the Concurrent Technologies AMC14) handles processing of the RLC and MAC layers in the simulated 5G NR stack.

Name	Description	Notes
USB	USB 2.0 connector	(Reserved for future use.)
RS-232	IEEE 1394 connector	(Reserved for future use.)
ETH2	RJ-45 connector	Usage depends on the hardware configuration selected on the HCCU Setup tab.
ETH3	RJ-45 connector	Usage depends on the hardware configuration selected on the HCCU Setup tab.

Slots 8, 9: DCB+ Connectors

Figure 4-7 UXM 5G Rear Panel -- DCB+ Connectors



These connectors relate to the DCB+ circuit board within the UXM 5G.

Name	Description	Notes
LAN	RJ-45	(reserved for future use)
TRIG_A1	SMA	Input/output trigger
ZQ, KB, KA indicators	LEDs	(reserved for future use)
TRIG_A2	SMA	Input/output trigger
DBG		(reserved for future use)
TRIG_B2	SMA	Input/output trigger
MMC A/B/C indicators	LEDs	(reserved for future use)
TRIG_B1	SMA	Input/output trigger
SPI	Synchronism ports	(reserved for future use)
BNC1/BNC2		Input/output triggers
(right side of card)	Optional BBIQ ports	(Not supported in E7515B)

Slot 10: AUXM Connectors

Figure 4-8 UXM 5G Rear Panel -- AUXM Connectors

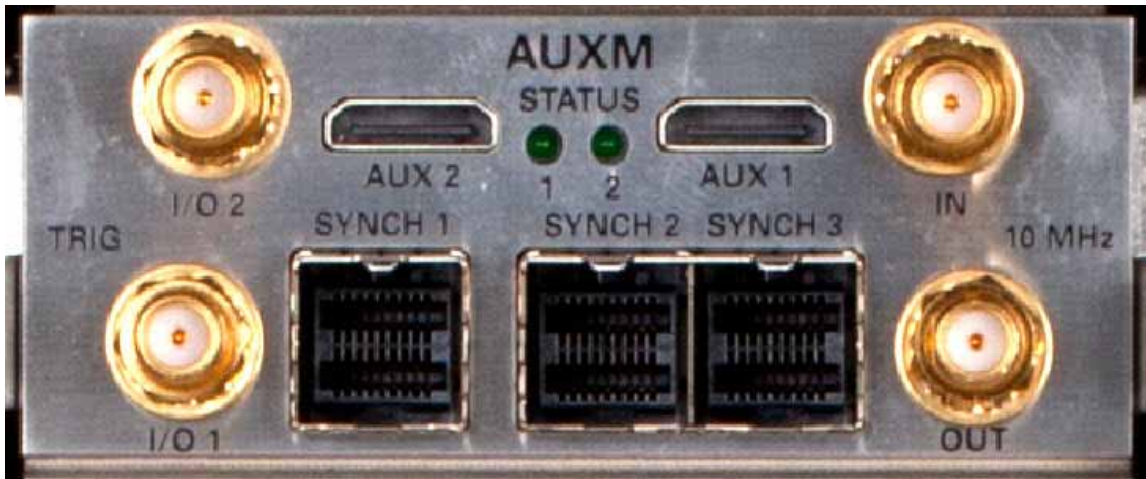

These connectors relate to the AUXM circuit board within the UXM 5G.

Name	Description	Notes
I/O 1 I/O 2	SMA connectors	(Reserved for future use.)
AUX 1 AUX 2	SMA connectors	(Reserved for future use.)
STATUS 1 STATUS 2	LEDs	(Reserved for future use.)
10 MHz IN 10 MHz OUT	SMA Input/Output 10 MHz clock reference	Do not modify connections to the internal and/or external references while this instrument is transmitting or receiving RF signals.
SYNCH 1 SYNCH 2 SYNCH 3	Mini-SAS HD 4x	Synchronizes the internal clocks between arrays of UXM 5G units.

Slots 11, 10: RFIO

Figure 4-9 UXM 5G Rear Panel -- RFIO Connectors



These connectors relate to the RFIO circuit board within the UXM 5G.

Name	Description	Notes
IF IN 3	SMA	(Reserved for future use.)
IF IN 4	SMA	(Reserved for future use.)
IF OUT 8	SMA	(Reserved for future use.)
IF OUT 7	SMA	(Reserved for future use.)
IF OUT 6	SMA	(Reserved for future use.)
IF OUT 5	SMA	(Reserved for future use.)
IF IN 1	SMA	(Reserved for future use.)
IF IN 2	SMA	(Reserved for future use.)
IF OUT 4	SMA	(Reserved for future use.)
IF OUT 3	SMA	(Reserved for future use.)
IF OUT 2	SMA	(Reserved for future use.)
IF OUT 1	SMA	(Reserved for future use.)

PCM

Figure 4-10 UXM 5G Rear Panel -- PCM Connectors



These connectors relate to the DCB+ circuit board within the UXM 5G.

Name	Description	Notes
SS USB	Four USB 3.0 ports.	(The front-panel USB ports are USB 2.0.)
Audio In	3.5 mm stereo	Audio jack connector for input.
Audio Out	3.5 mm stereo	Audio jack connector for output.













AC Power

The E7515B requires two AC power inputs. Both AC inputs must be connected and powered to operate the instrument. If either of the two inputs is not present, the instrument will not boot (or will shut down, if already in operation). See **“AC power safety” on page 18** for more information.



NOTE

Some E7515B instruments have an older power supply design, which includes only a single AC power input.

Front and Rear Panel Symbols

Symbol	Description
	This symbol is used to indicate power ON.
	This symbol is used to indicate power OFF.
	This symbol is used to indicate power STANDBY mode (yellow in standby, green when instrument is ON).
	This symbol indicates the input power required is AC.
	This symbol indicates earth ground.
	The instruction documentation symbol. The product is marked with this symbol when it is necessary for the user to refer to instructions in the documentation.
	The CE mark is a registered trademark of the European Community.
	The RCM Mark is a Compliance Mark according to the ACMA Labeling Requirement.
	South Korean Certification (KC) mark; includes the marking's identifier code which follows this format: MSIP-REM-YYY- <u>ZZZZZZZZZZZZ</u>
	ICES / NMB-001 Cet appareil ISM est conforme a la norme NMB du Canada. This is a marking to indicate product compliance with the Industry Canadian Interference-Causing Equipment Standard (ICES-001). This is also a symbol of an Industrial Scientific and Medical Group 1 Class A product (CISPR 11, Clause 4).
	The CSA mark is a registered trademark of the CSA International.
	This symbol indicates separate collection for electrical and electronic equipment mandated under EU law as of August 13, 2005. All electric and electronic equipment are required to be separated from normal waste for disposal (Reference WEEE Directive 2002/96/EC).

Front and Rear Panel Functions
Front and Rear Panel Symbols

Symbol	Description
 A circular icon with the number '40' in the center, surrounded by two curved arrows forming a circle, indicating a 40-year warranty.	Indicates the time period during which no hazardous or toxic substance elements are expected to leak or deteriorate during normal use. Forty years is the expected useful life of the product.
 A standard recycling symbol consisting of three chasing arrows forming a triangle.	This symbol on all primary and secondary packaging indicates compliance to China standard GB 18455-2001.

Front and Rear Panel Functions
Front and Rear Panel Symbols

5 Test Platform Operating System

The following topics can be found in this section:

[“Keysight Software Installed” on page 66](#)

[“User Accounts” on page 67](#)

[“System Maintenance” on page 71](#)

[Updating the Keysight E7515B UXM 5G software on page 77](#)

[Updating the Keysight 5G NR Test Application on page 79](#)

Keysight Software Installed

Your test platform has a software application already installed: the C8700200A Test Application Framework.

Customer Installation of Software

If for some reason you need to re-install any software you purchased, go to www.keysight.com/find/softwaremanager to obtain the latest version.

Refer to **Chapter , “Updating the Keysight E7515B UXM 5G software”, on page 77** for software installation instructions.

Uninstalling Keysight Software

Uninstallation is a dialog driven process. You can access the uninstall dialog of the Keysight Test Application software within the Windows **Start** menu, or by using the **Start > Control Panel\All Control Panel Items\Programs and Features** dialog within Windows.

Installation of Third Party Software

It is recommended that you do not install any non-approved software on the UXM 5G. Installation of third party software on the UXM 5G may render the system inoperative and is not supported by Keysight Technologies.

User Accounts

The E7515B ships with only one account set up (the Administrator account). Setting up additional user accounts is not recommended, as this would likely create problems of compatibility with the installed firmware.

Administrator Account

Using the Administrator account you can perform the following operations:

- Install software
- Configure network and printer access
- Access all files on the instrument
- Add or change user accounts and passwords (see **“Changing Account Passwords” on page 68**).
- Change Firewall settings
- Change Windows settings (e.g., using Device Manager)
- Change the time and date
- Run Keysight applications

For instruments with a Keysight Technologies disk image, the Administrator account ships from the factory with the password set as:

Keysight4u!

Changing Account Passwords

In order to minimize an “unnoticed” or “involuntary” change of the Administrator account password, the account properties have been set to restrict password change. If you need to change the password for this account, proceed as follows:

Step	Notes
1.	Log in to the instrument as Administrator.

Use the Windows Search icon in the lower left of the desktop to search for (and select) **Administrative Tools**.

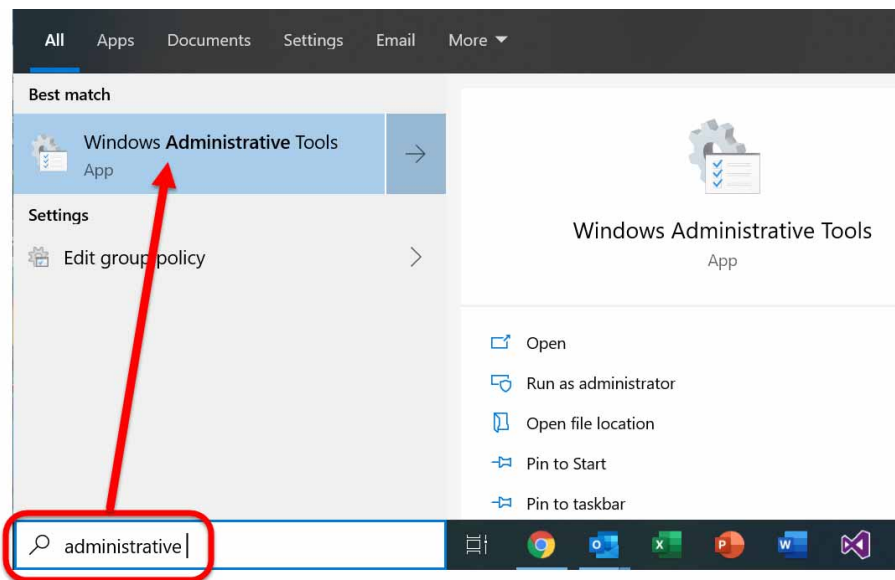

Locate and select **Computer Management**.

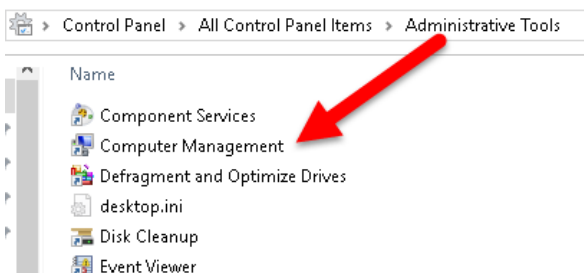

Test Platform Operating System
User Accounts

Step	Notes
------	-------

- a. Locate and select **Users**
- b. **Administrator**
- c. **More Actions**
- d. **Properties**

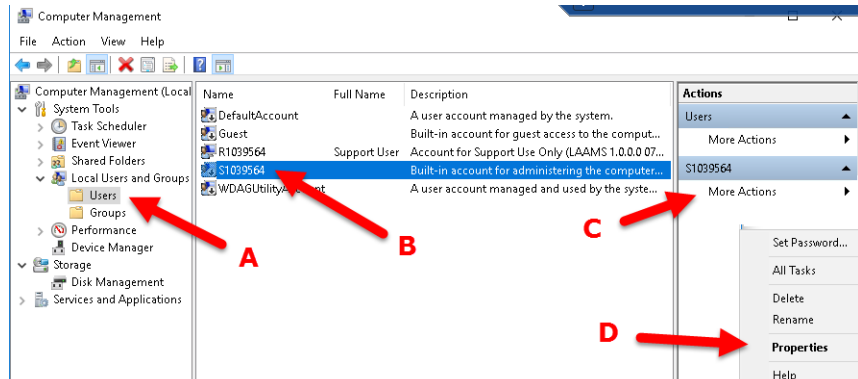

Clear the check box next to "User cannot change password" and then select **OK**.

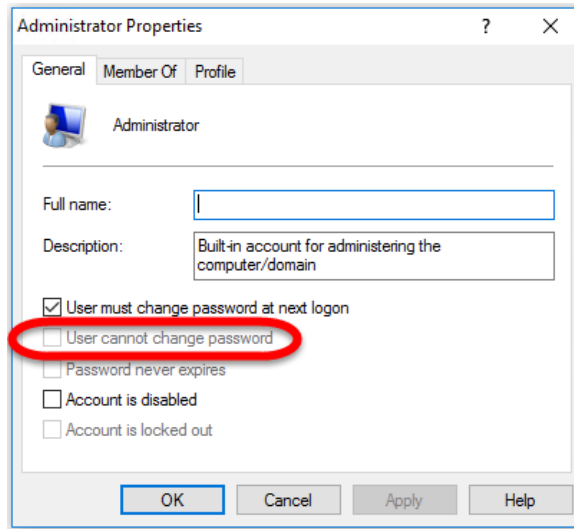

Step	Notes
------	-------

After you have changed the Administrator Properties, change your password by pressing **Ctrl+Alt+Del** then **Change Password**.

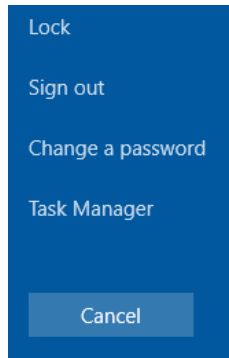

2. Enter the password change information.
 - a. The account to be changed ("Administrator").
 - b. The old password
 - c. The new password.
 - d. Re-enter the new password to confirm. (Complete the operation by pressing Enter or clicking the arrow icon.)

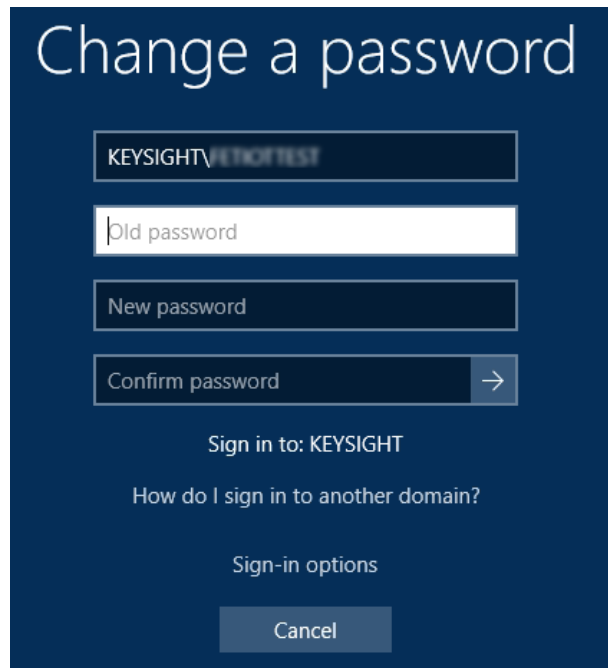

3. After changing the password(s), repeat steps 2 through 8.

After changing the password(s), it is recommended that you restore the "User cannot change password" Administrator property (see step 8).

System Maintenance

Back-up

It is recommended that you have a regular back-up strategy. Your IT department may already have a back-up strategy in place which is suitable for the test platform and its data.

The Windows 10 operating system has a Backup utility that you can use to archive files and folders in case of a hard disk drive failure. See the Microsoft Windows Help and Support Center for more information on this utility.

When performing back-ups, we recommend that you back-up the data to an external storage device connected to your company's internal network or one of the test platform's USB connectors. Also, you should perform back-ups at times when the Server PC is not being used for normal operations as it may impact the test platform's overall performance.

System Restore

Windows 10 contains the capability to restore the system to a previous point in time. System Restore is enabled with default settings as provided by Microsoft. However, System Restore is not 100% successful. Therefore, it is not the recommended method to back-up the instrument. System Restore has not been tested to verify successful restoring. It is best to use the procedure described in **“Disk Drive Recovery Process” on page 73.**

Hard Drive Partitioning and Use

The drive is partitioned into 3 sections: C:, D: and E:

- The **C:** partition contains the Windows 10 operating system and software installed by Keysight. This is an Open System which means you can install additional software. However it is recommended that you use an external PC to host all additional software applications that you wish to use in conjunction with the UXM 5G. The installation and/or use of other software is not warranted and could interfere with the operation of the test platform software. If instrument repair is ever needed, the Keysight version of the C: drive is the only part of the instrument software that is restored by the Instrument Image Recovery System. You must reload any other software that you have added in the instrument.

NOTE

It is recommended that you use an external PC to host software applications you wish to use in conjunction with the UXM 5G. Installing applications on the instrument Host PC may result in a compromised performance of the UXM 5G including decreased throughput and/or measurement performance.

- The **D:** partition is reserved for data storage. This is for the convenience of backing-up the test platform measurement data. You should always back-up the data on the D: drive to an external device. This enables you to restore the data should the hard drive need to be replaced.

NOTE

Data on the desktop will be deleted during system recovery. Therefore it is recommended that you always store your data in another folder on the D: drive, for example **D: \MyData**

- The **E:** partition is reserved for Keysight's use. The primary use of the E: drive is for storing the Calibration and Alignment data, the configuration files for the Platform Boards and Host PC. Do not change or overwrite the files on this drive. This could cause your instrument to not meet specifications, or even to stop functioning correctly. Do not use this drive for data storage. It is also recommended that you back-up the contents of this drive by using an external device.

Disk Drive Recovery Process

The Instrument Image Recovery System can be used to repair errors on the instrument's C: drive or to restore the original factory configuration of the system software. Repairing errors on the hard disk drive may result in loss of data or files. If you need more information about the Windows "chkdsk" error repair process, see the chkdsk documentation in the Microsoft Windows 10 Help and Support Center.

NOTE

This recovery process should only be used for the repair/restoration purposes described above. It is **not** suitable for performing an instrument software update; see ["Updating the Keysight E7515B UXM 5G software" on page 77](#) for the appropriate procedure.

Restoring the original factory system software does not restore any of the following items:

- Windows system configurations that were made after the instrument was shipped from the factory. For example, Windows and Service Pack updates, user accounts, and Windows configuration settings. After an Instrument Image Recovery System, these configurations need to be redone.
- Additional software that was installed after the instrument was shipped from the factory. After an Instrument Image Recovery System, that software needs to be re-installed.
- Any upgrades that were made to the Keysight Test Application software.

NOTE

It is recommended that you use a regular back-up strategy. Your IT department may already have a back-up strategy in place which is suitable for the Internal Applications Server and its data. See ["User Accounts" on page 67](#). Using the Instrument Image Recovery System in conjunction with a regular back-up strategy should allow you to fully recover the Internal Applications Server software and data.

It is recommended that routine back-ups of the instrument information be performed to keep current archives of the instrument information. This allows a full recovery of the instrument information after the instrument recovery system operations are performed. See ["Back-up" on page 71](#) for more details.

Using the Instrument Image Recovery System - Test Platform Operating System

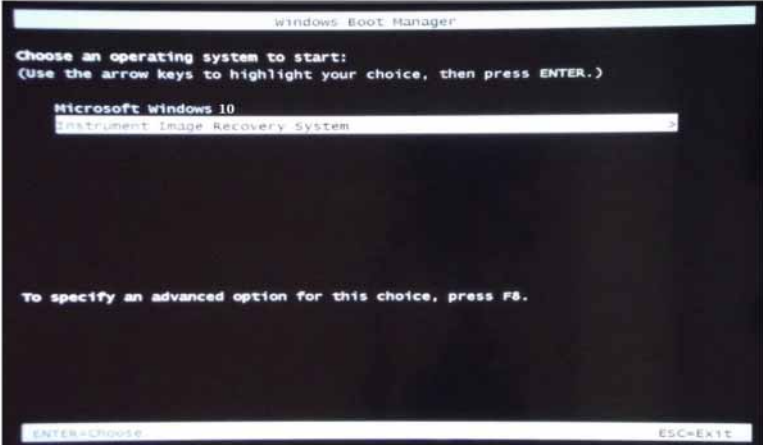
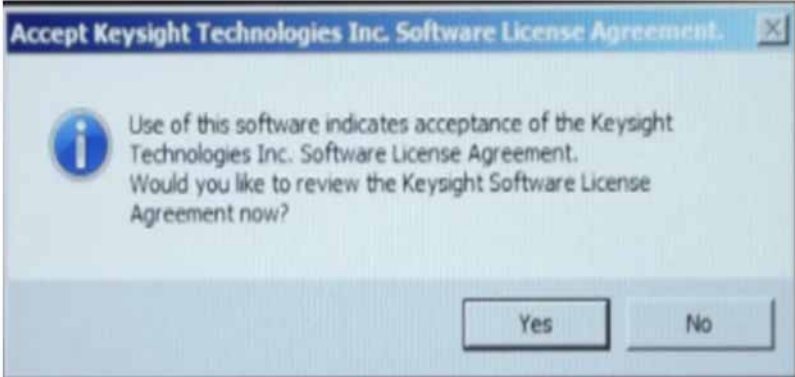
Step	Notes
<p>Turn on the instrument.</p> <p>Press the down arrow key to move the highlight to Instrument Image Recovery System, and then press Enter.</p>	<p>The Windows Boot Manager Screen is displayed.</p> 
<p>After selecting the Instrument Image Recovery System, the instrument boots the Instrument Image Recovery System for 2 or 3 minutes. Finally, the instrument displays a message asking if you would like to review the Keysight license agreement. Select Yes.</p>	

Step	Notes
------	-------

- 4. Review the terms.
Select the "X" in the upper right corner to close this window.

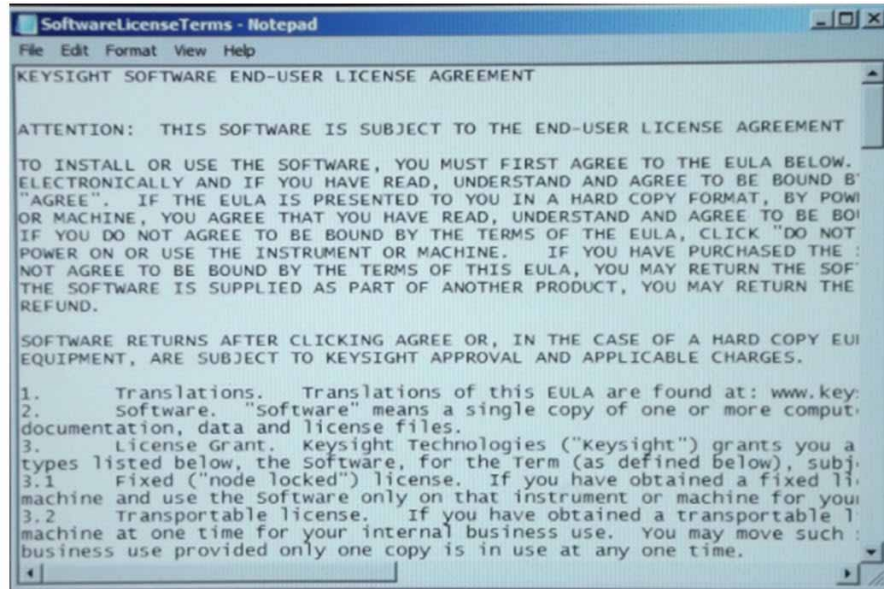

- Accept the license agreement by selecting **Yes**.

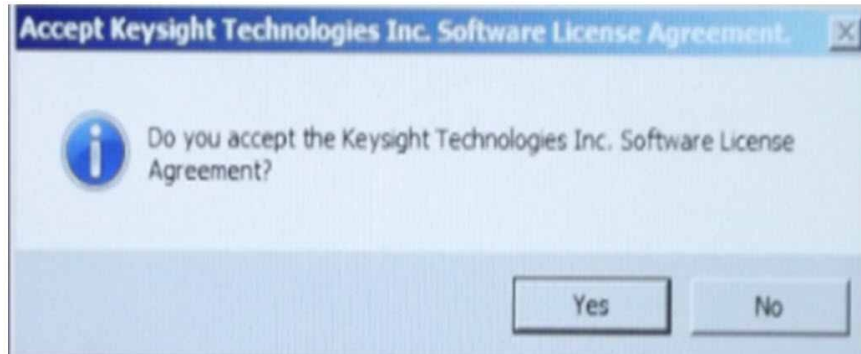

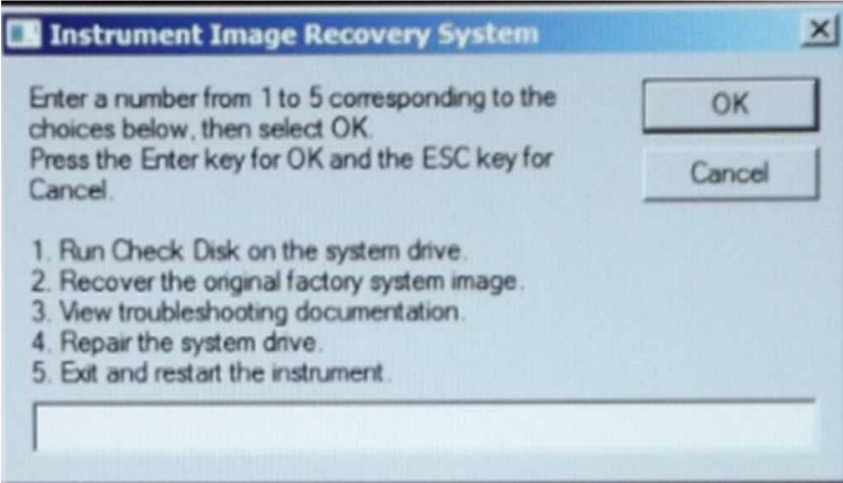
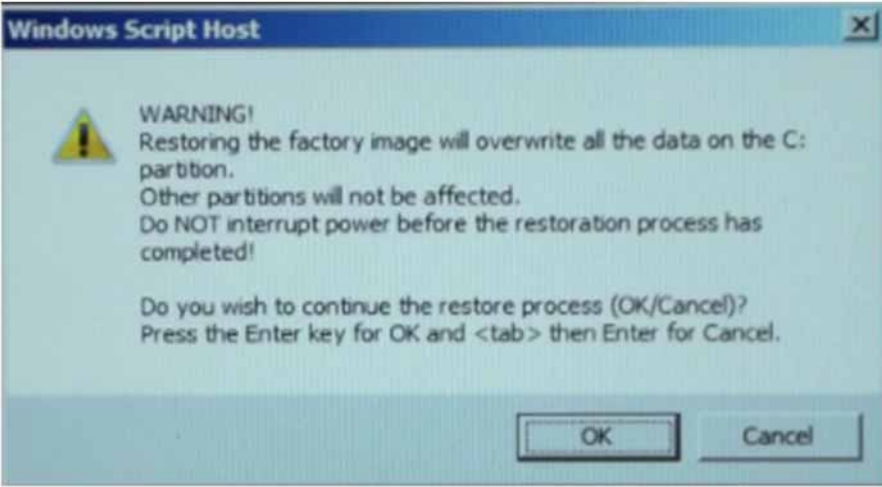
Step	Notes
<p>When the Instrument Image Recovery System has booted, follow the on-screen instructions to recover the image of the C: drive.</p> <p>Type in the number 2, then press OK to select “Recovery of the original factory system image”.</p>	
<p>A warning message appears. Press OK to start the recovery, which may take up to 45 minutes to complete.</p>	
<p>5. The instrument then re-executes the process described under: “Turning On the Test Platform the First Time” on page 31.</p>	

Updating the Keysight E7515B UXM 5G software

The following steps are required to upgrade your Keysight E7515B UXM 5G firmware. Downgrading to an earlier version is also possible, using the same process.

Using the E7515B/E7515B UXM 5G Firmware Update Tool

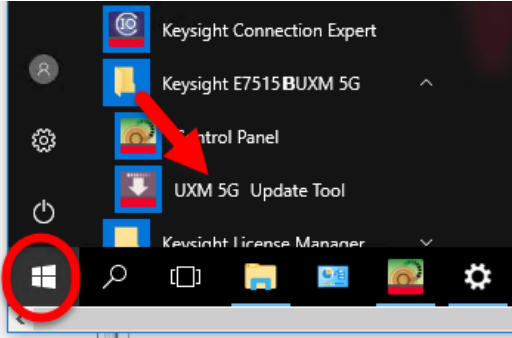
Step	Notes
1. Connect a USB keyboard and mouse to the instrument	
Log in as follows: User Name: Administrator Password: Keysight4u!	
Obtain the latest version of software installer.	Download it from the site: www.keysight.com/find/softwaremanager
Launch Firmware Upgrade Tool from the Windows menu at the lower left corner of the desktop (it should be under Keysight E7515B UXM 5G).	 <p>If this application is not installed, download the latest recommended version of “Keysight E7515B/E7515B UXM 5G Firmware UpdateTool” from the site: www.keysight.com/find/softwaremanager</p>
2. In the “UXM 5G Update Tool” add the software installer program obtained in the step 4.	Right-click on the Windows “Select firmware version:” and Add it.
Select the desired software installer and click the Update UXM5G Firmware button.	If the instrument belongs to an Array, the instrument is exited from Array.
When prompted to continue with the Firmware update, select Yes .	The Firmware Update Tool will warn if a system restart is required for completing the uninstallation/installation.
If a system restart is required, a confirmation message will appear when restart is needed. In that case, when prompted to continue with the restart, select Yes .	This typically happens when Microsoft .NET Framework must be updated.

Step	Notes
3. The “UXM5G Update Tool” will continue by itself after the instrument restarts, and will finish the update. Then a confirmation button will be shown.	
4. In case of an error during upgrade, the “UXM5G UpdateTool” will inform the user. In that case, you can try to repair it manually or contact Support team.	To manually repair the software upgrade, go to “Control Panel\Programs\Programs and Features” and: (a) Uninstall Keysight E7515B Application (b) Uninstall Keysight E7515B UXM 5G (c) Repeat the upgrade from step 5 above. If this is not successful, you must contact the Support team.

Updating the Keysight 5G NR Test Application

The following steps are required to update your Keysight UXM 5G software with the Keysight 5G NR Test Application.

This software is licensed. Look for latest software versions at:

<http://www.keysight.com/find/softwaremanager>

Updating the Application

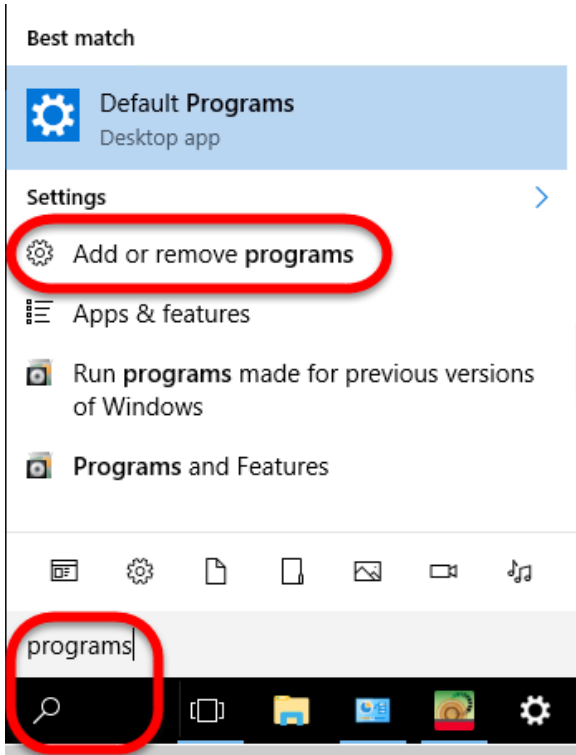
Step	Notes
1. Connect a USB keyboard and mouse to the instrument	
At the log in prompt enter: User Name: Administrator Password: Keysight4u!	
2. Close the UXM 5G Control Panel.	Click the "X" icon in the upper right corner of Control Panel.
Use the Windows Search icon in the lower left of the desktop to search for "programs". Select Add or remove programs in the matches displayed..	 A screenshot of the Windows search interface. The search bar at the bottom left contains the text "programs" and is circled in red. Below the search bar, a list of search results is displayed. The first result is "Default Programs" with a gear icon and the text "Desktop app". Below this is a "Settings" section with a right-pointing arrow. The first item in the settings list is "Add or remove programs" with a gear icon, which is circled in red. Other items in the settings list include "Apps & features", "Run programs made for previous versions of Windows", and "Programs and Features". At the bottom of the search results, there is a row of icons for various system functions: a document, a gear, a file, a folder, an envelope, a video camera, and a music note.

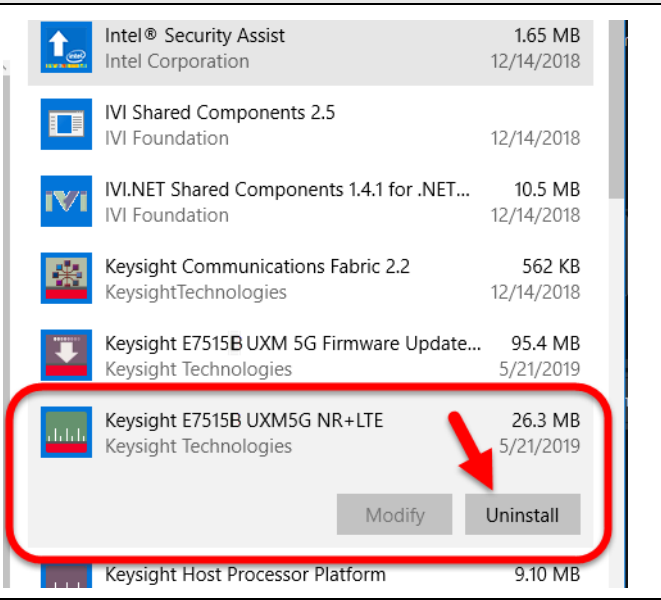
Step	Notes																																
<p>Scroll to find the Keysight E7515B application, and select Uninstall.</p>	 <table border="1"> <thead> <tr> <th>Application Name</th> <th>Size</th> <th>Company</th> <th>Date</th> </tr> </thead> <tbody> <tr> <td>Intel® Security Assist</td> <td>1.65 MB</td> <td>Intel Corporation</td> <td>12/14/2018</td> </tr> <tr> <td>IVI Shared Components 2.5</td> <td></td> <td>IVI Foundation</td> <td>12/14/2018</td> </tr> <tr> <td>IVI.NET Shared Components 1.4.1 for .NET...</td> <td>10.5 MB</td> <td>IVI Foundation</td> <td>12/14/2018</td> </tr> <tr> <td>Keysight Communications Fabric 2.2</td> <td>562 KB</td> <td>KeysightTechnologies</td> <td>12/14/2018</td> </tr> <tr> <td>Keysight E7515B UXM 5G Firmware Update...</td> <td>95.4 MB</td> <td>Keysight Technologies</td> <td>5/21/2019</td> </tr> <tr> <td>Keysight E7515B UXM5G NR+LTE</td> <td>26.3 MB</td> <td>Keysight Technologies</td> <td>5/21/2019</td> </tr> <tr> <td>Keysight Host Processor Platform</td> <td>9.10 MB</td> <td></td> <td></td> </tr> </tbody> </table>	Application Name	Size	Company	Date	Intel® Security Assist	1.65 MB	Intel Corporation	12/14/2018	IVI Shared Components 2.5		IVI Foundation	12/14/2018	IVI.NET Shared Components 1.4.1 for .NET...	10.5 MB	IVI Foundation	12/14/2018	Keysight Communications Fabric 2.2	562 KB	KeysightTechnologies	12/14/2018	Keysight E7515B UXM 5G Firmware Update...	95.4 MB	Keysight Technologies	5/21/2019	Keysight E7515B UXM5G NR+LTE	26.3 MB	Keysight Technologies	5/21/2019	Keysight Host Processor Platform	9.10 MB		
Application Name	Size	Company	Date																														
Intel® Security Assist	1.65 MB	Intel Corporation	12/14/2018																														
IVI Shared Components 2.5		IVI Foundation	12/14/2018																														
IVI.NET Shared Components 1.4.1 for .NET...	10.5 MB	IVI Foundation	12/14/2018																														
Keysight Communications Fabric 2.2	562 KB	KeysightTechnologies	12/14/2018																														
Keysight E7515B UXM 5G Firmware Update...	95.4 MB	Keysight Technologies	5/21/2019																														
Keysight E7515B UXM5G NR+LTE	26.3 MB	Keysight Technologies	5/21/2019																														
Keysight Host Processor Platform	9.10 MB																																
<p>When prompted to completely remove the selected application and all of its features, select Yes.</p> <p>When the software uninstall is complete, select Finish.</p>	<p>The UXM 5G Control Panel should be closed at the beginning of the uninstallation. You must launch it manually at the end of this process.</p>																																
<p>3. Obtain the latest version of software installer.</p>	<p>Download it from the site: www.keysight.com/find/softwaremanager</p>																																
<p>4. Locate the software installer program obtained in the step above.</p>																																	
<p>5. Follow the on-screen prompts to continue the installation.</p>	<p>CAUTION The installation process takes about 2 minutes. Do not turn the instrument power off or serious damage may occur. If any pop-up windows appear, click OK or Ignore to proceed.</p>																																
<p>When the installation has finished, you must manually launch the UXM 5G Control Panel (from Desktop or Windows > Start).</p>																																	
<p>6. Verify the UXM 5G is operational.</p>	<p>If the Control Panel shows a Faulty state, restart the UXM 5G or power cycle the UXM 5G as follows:</p> <ol style="list-style-type: none"> Power off the UXM 5G and disconnect the power cord for 15 seconds. Power on the UXM 5G. 																																

Once the application software has been installed, you must follow the instructions provided in **“Licensing” on page 37** in order to install the license required (if not previously installed), and select and start up the application as described in the procedure **“Turning On the Test Platform the First Time” on page 31**.

Installation of Third Party Software

It is recommended that you do not install any software not provided by Keysight, unless the Keysight installer instructs you to add it. Installation of third party software on the UXM 5G may render the system inoperative and is not supported by Keysight Technologies.

6 Troubleshooting

The following topics can be found in this section:

“Identifying Problems” on page 84

“Returning Your Test Set for Service” on page 85

Identifying Problems

WARNING

No operator serviceable parts inside. Refer servicing to qualified personnel. To prevent electrical shock do not remove covers.

1. Select the **Reboot** button on the System tab of the HCCU utility whenever the UXM 5G hardware and/or software appear to be in a faulty state. Once the UXM 5G image shows a green check mark, the UXM 5G is in the ready state and you can proceed with your testing. Note that you may need to perform this reboot more than once to obtain the green display indicator condition. Note that the Restart and Shutdown affect the test set and Windows.
2. If you need to refer the problem to your Keysight representative, use the **Export Logs** feature on the **System** tab of the **HCCU**, and send the resulting file to Keysight for reference.

Figure 6-1 Using the HCCU utility in troubleshooting

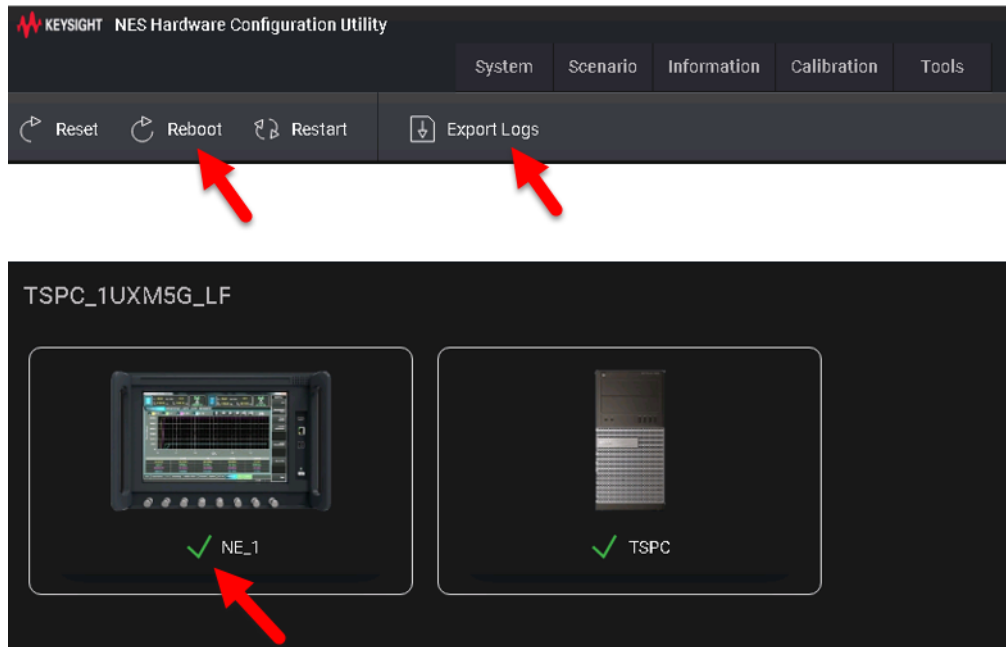

Returning Your Test Set for Service

Calling Keysight Technologies

Keysight Technologies has offices around the world to provide you with complete support for your wireless test set. To obtain servicing information, or to order replacement parts, contact the nearest Keysight Technologies office listed under **“Locations for Keysight Technologies” on page 86**. In any correspondence or telephone conversations, refer to your test set by its product number, full serial number, and software revision.

To access your product information, select the Info icon  in the E7515B Control Panel view after switching to the E7515B Control Panel via the Application Switch tool or after performing both or only the second action described below:

1. To access the Windows task bar from inside the TA/LA software application, you can use the Application Switch tool to switch to the desktop and find the task bar, or you can connect the USB keyboard to the UXM 5G using one of the USB ports located on the front and rear panels of

the UXM 5G. Press the key showing the windows icon , which is usually located in the lower-left corner of the keyboard.

2. Once you have access to the windows task bar, double-click the E7515B

Control Panel icon  to maximize the E7515B Control Panel view.

Locations for Keysight Technologies

For online assistance: <http://www.keysight.com/find/assist>

To contact Keysight Technologies: <http://www.keysight.com/find/contactus>

Alternately, contact the nearest Keysight sales office:

Americas		
Canada (877) 894 4414	Brazil 55 11 3351 7010	Mexico 001 800 254 2440
United States (800) 829 4444		
Asia & Pacific		
Australia 1 800 629 485	China 800 810 0189	Hong Kong 800 938 693
India 1 800 112 929	Japan 0120 (421) 345	Korea 080 769 0800
Malaysia 1 800 888 848	Singapore 1 800 375 8100	Taiwan 0800 047 866
Other Asia-Pacific countries: (65) 6375 8100		
Europe & Middle East		
Austria 0800 001122	Belgium 0800 58580	Finland 0800 523252
France 0805 980333	Germany 0800 6270999	Ireland 1800 832700
Israel 1 809 343051	Italy 800 599100	Luxembourg +32 800 58580
Netherlands 0800 0233200	Russia 8800 5009286	Spain 0800 000154
Sweden 0200 882255	Switzerland 0800 805353 Opt. 1 (DE), Opt. 2 (FR), Opt. 3 (IT)	United Kingdom 0800 0260637



This information is subject to change without notice.

© Keysight Technologies 2014-2021

Edition 1, October 2021

E7515-90040

www.keysight.com